

# take off

design:  
Gianantonio Perin

**Angoli arrotondati e piani minimalisti, geometria squadrata per le gambe a cavalletto. Il design di Take-Off Evo e Take-Off Country è un equilibrio elegante tra morbidezza e rigore.**

Rounded corners and minimalist tops, squared geometry for the A frame legs. Take-Off Evo and Take-Off Country's design is an elegant balance between softness and rigor.

Coins arrondis et plateaux minimalistes, géométrie carrée pour les pieds en chevalet. Le design de Take-Off Evo et de Take-Off Country est un élégant équilibre entre douceur et rigueur.

Abgerundete Ecken und minimalistische Platten, quadratische Geometrie für die A-Fussgestelle. Das Design von Take-Off Evo und von Take-Off Country ist eine elegante Balance zwischen Weichheit und Strenge.

Esquinas redondeadas y tapas minimalistas, geometría cuadrada para las patas de caballete. El diseño de Take-Off Evo y Take-Off Country es un elegante equilibrio entre suavidad y firmeza.



Take-Off Evo

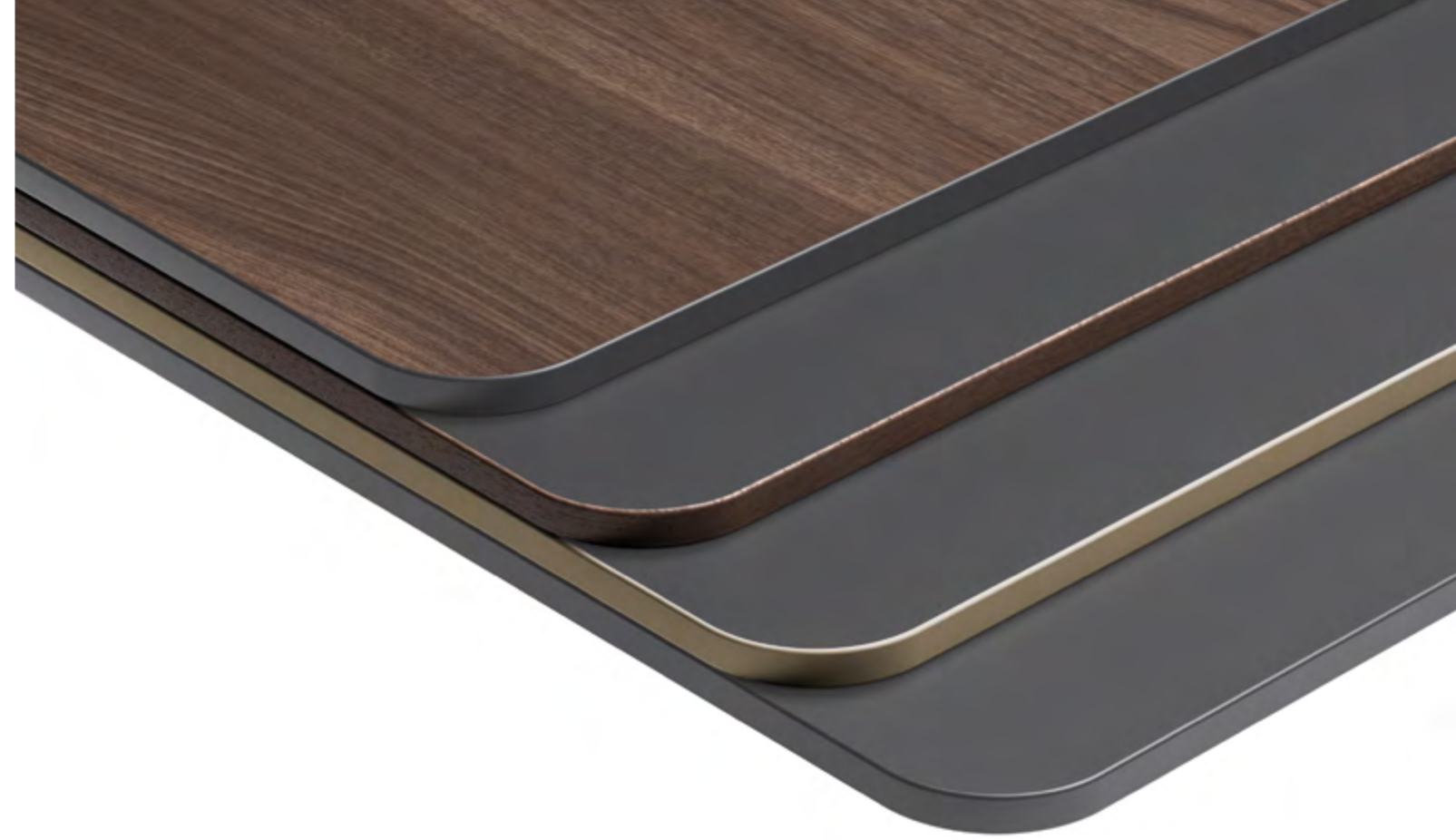

**I bordi a contrasto di Take-Off Evo. L'energia degli opposti che personalizza le postazioni di lavoro operative.**

The color-contrasting edges of Take-Off Evo. The energy of opposites personalizing workplaces.

Les chants contrastés de Take-Off Evo. L'énergie des contraires qui personnalise les postes de travail opérationnels.

Die farblich abgesetzten kanten des neuen Take-Off Evo. Die Energie der Kontraste um die Arbeitsplätzen etwas Besonderes zu machen.

Los bordes contrastantes de Take-Off Evo. La energía de lo opuesto que personaliza los puestos de trabajo operativos.



Take-Off Evo





Take-Off Country

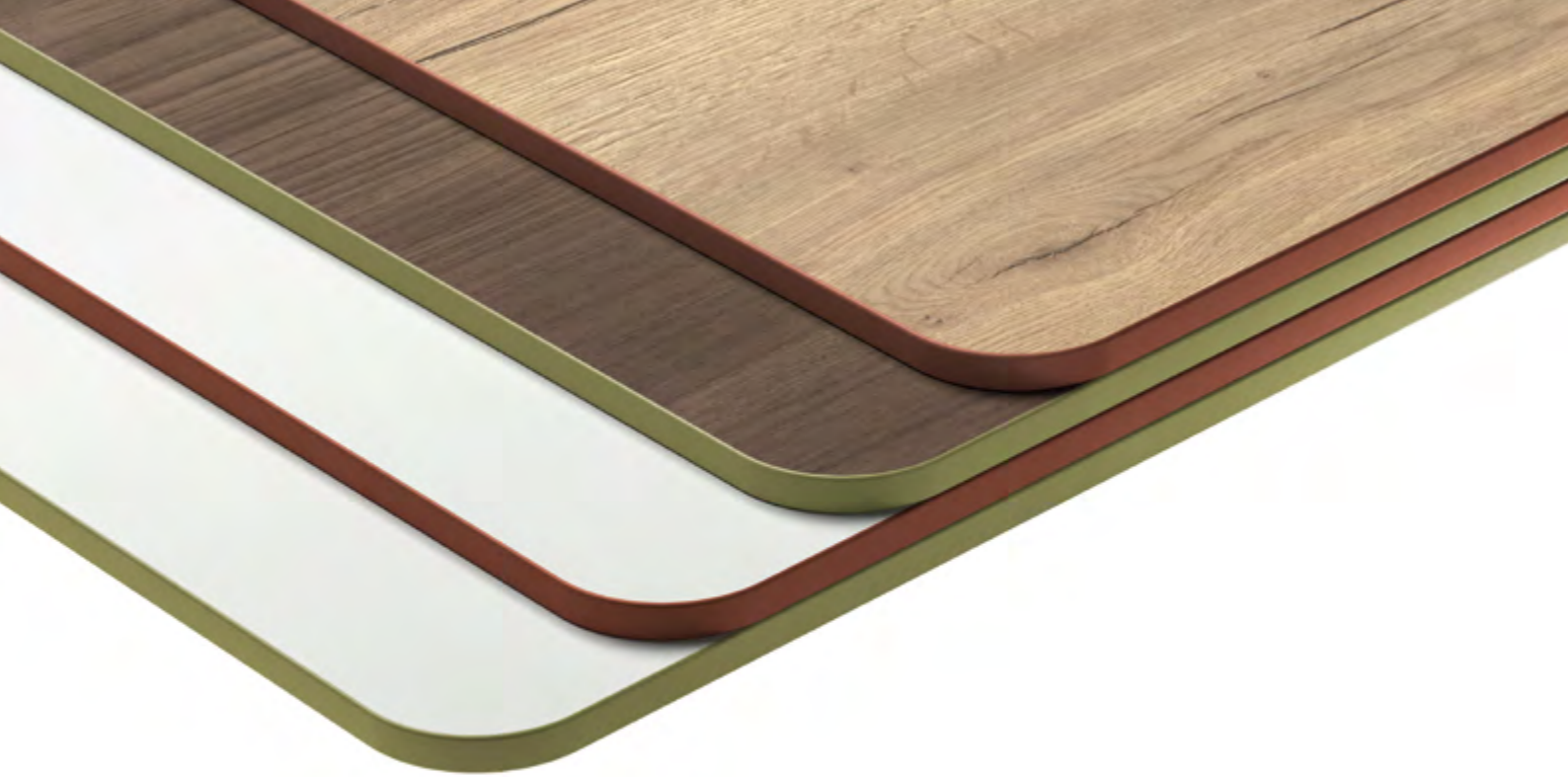

**Take-Off Country si caratterizza per la struttura in finitura rovere antico che trasmette calore all'ambiente ufficio.**

Take-Off Country is characterized for the support frame in antiqued oak finish that conveys the sense of warmth to the office environment.

Take-Off Country se caractérise par une structure en chêne vieilli qui transmet un sentiment de chaleur dans l'environnement de bureau.

Take-Off Country wird geprägt vom Gestell aus Eiche Antik, einer Oberfläche, die der Büroumgebung eine warme Note verleiht.

Take-Off Country está caracterizado por su estructura en melamina roble antiguo que transmite calor al ambiente de trabajo.







Take-Off Evo





Take-Off Country

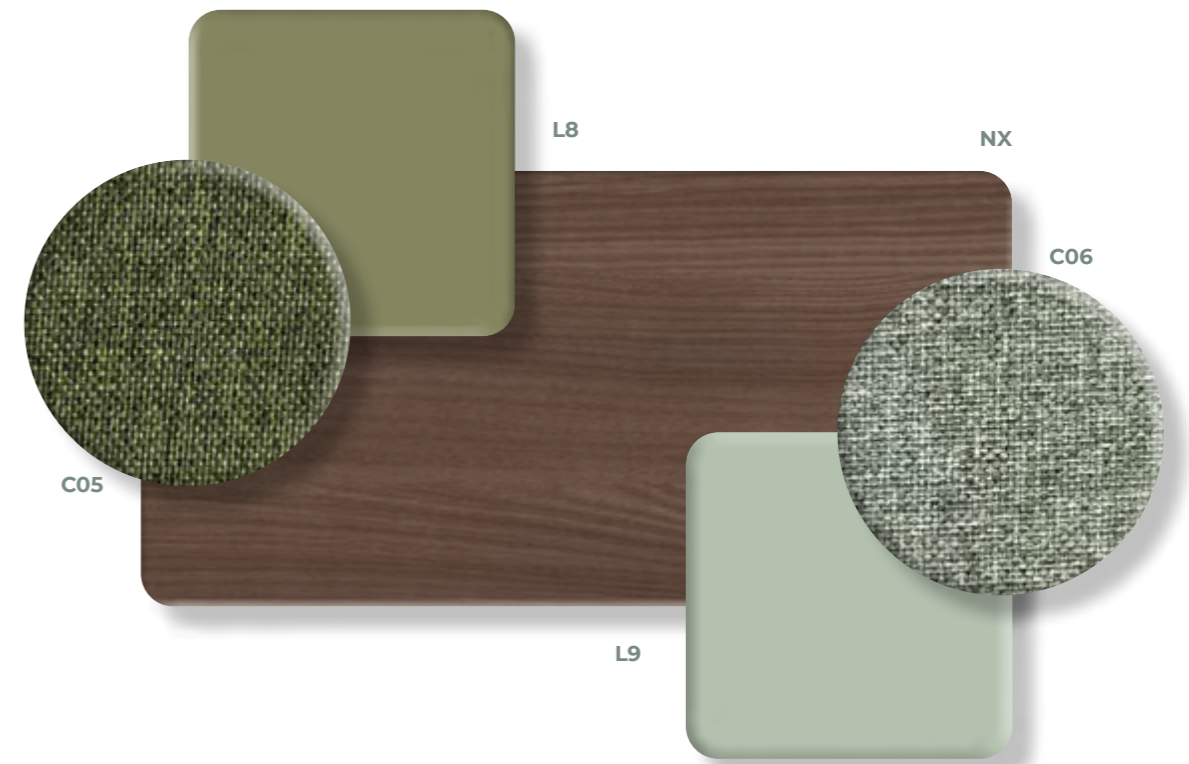
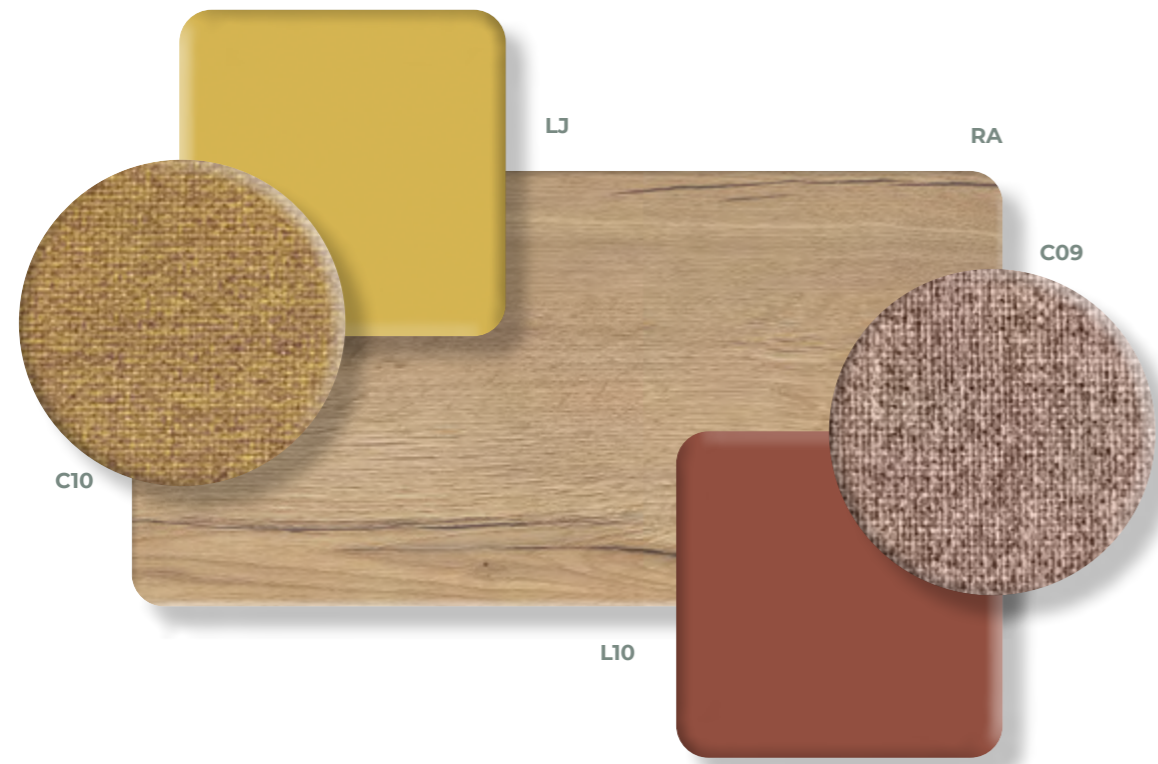
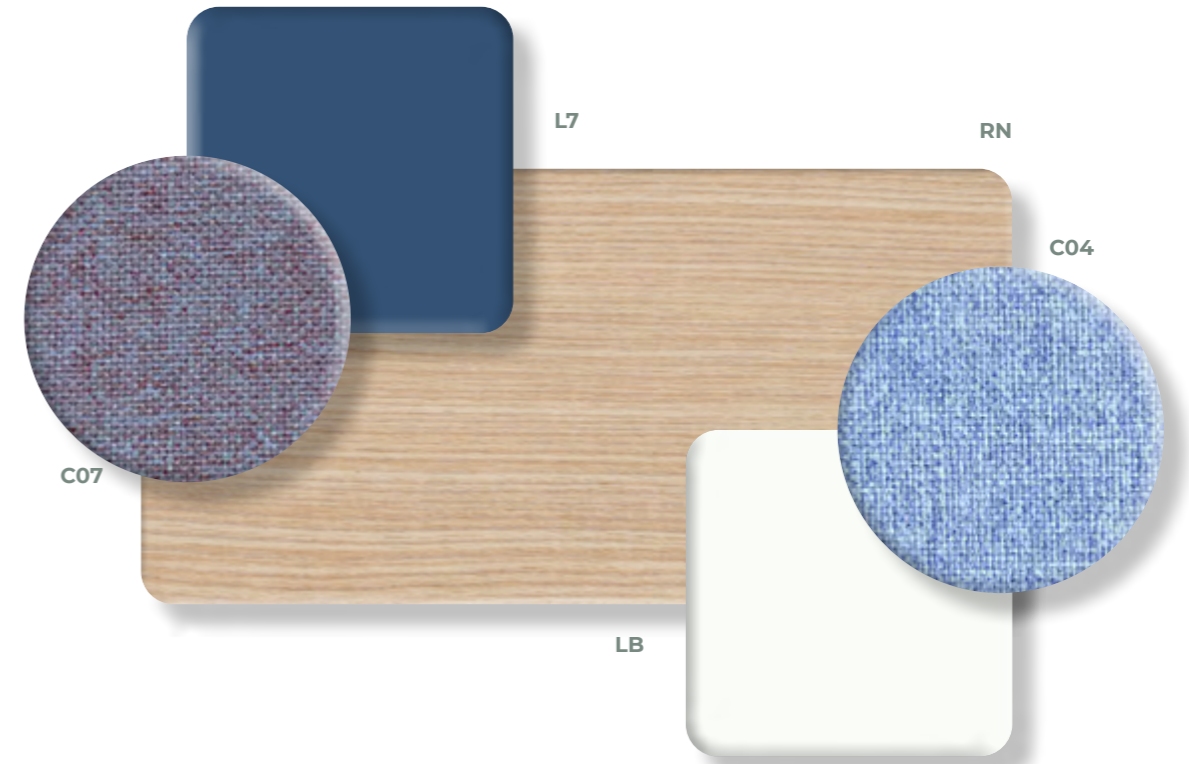
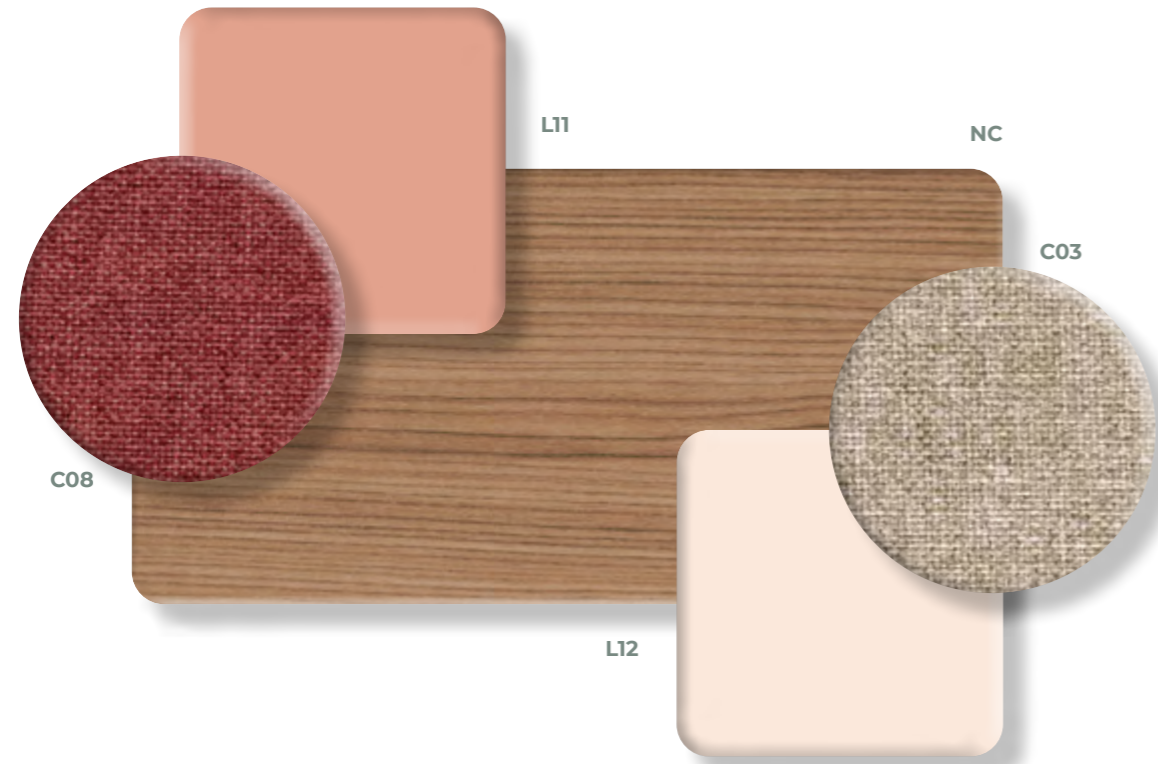



h 74 cm

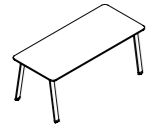

w 100÷200 cm  
d 60-80 cm



w 140÷200 cm  
d 80 cm

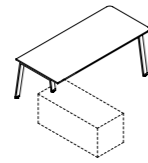

w 140÷200 cm  
d 80 cm

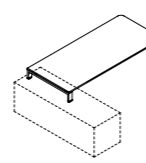

w 140÷200 cm  
d 80 cm

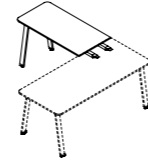

w 120 cm  
d 60 cm

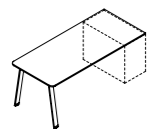

w 140÷200 cm  
d 80 cm

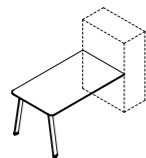

w 140÷200 cm  
d 80 cm

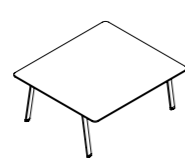

w 140÷200 cm  
d 124-164 cm

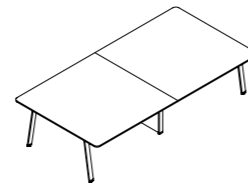

w 280÷480 cm  
d 124-164 cm

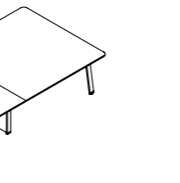

w 320÷400 cm  
d 100 cm

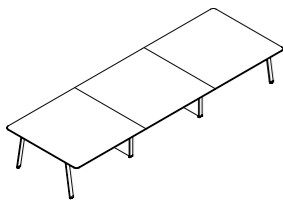

w 420÷600 cm  
d 124-164 cm

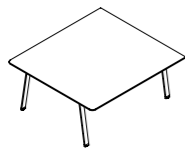

w 140÷200 cm  
d 124-164 cm

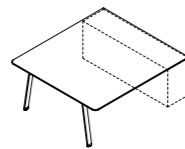

w 140÷200 cm  
d 124-164 cm

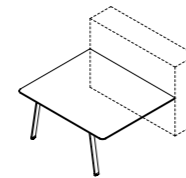

w 140÷200 cm  
d 164 cm

h 74 cm

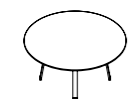

∅ 118-140-160 cm

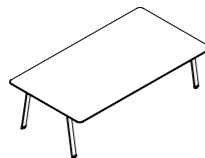

w 180÷240 cm  
d 100 cm

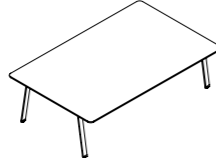

w 180÷280 cm  
d 124-164 cm

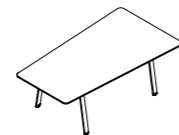

w 220 cm  
d 124 cm



w 60-120 cm  
d 60 cm

h 43 cm

h 105 cm



w 140÷200 cm  
d 70-80-100-124 cm

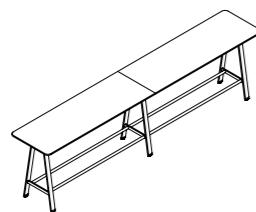

w 280÷400  
d 70-80-100-124 cm

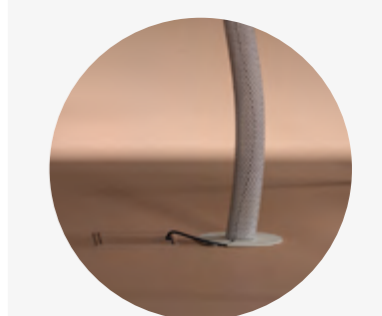
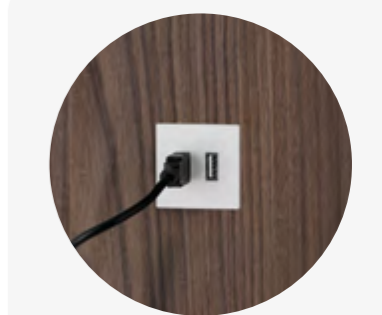
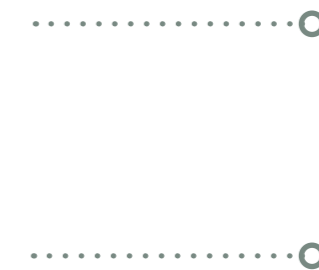
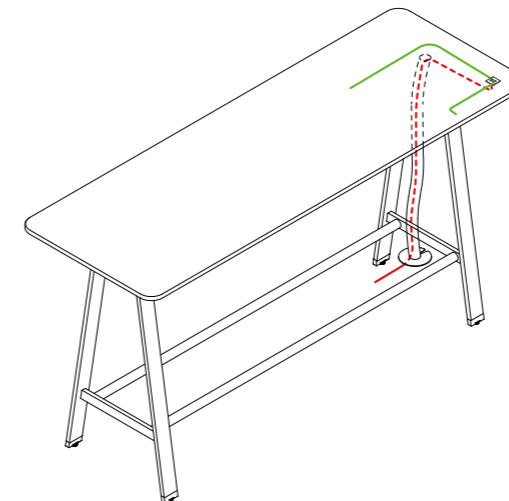
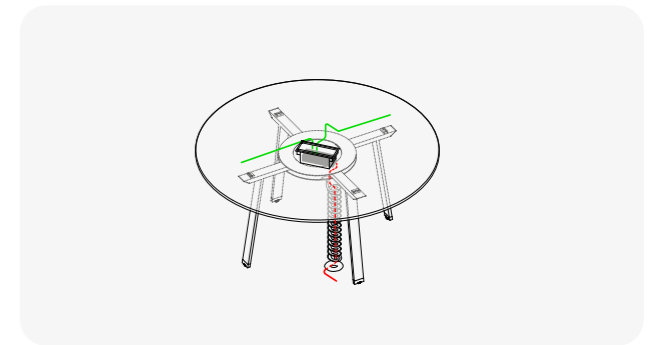
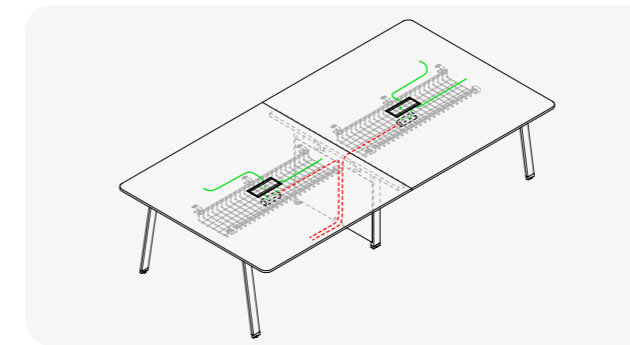
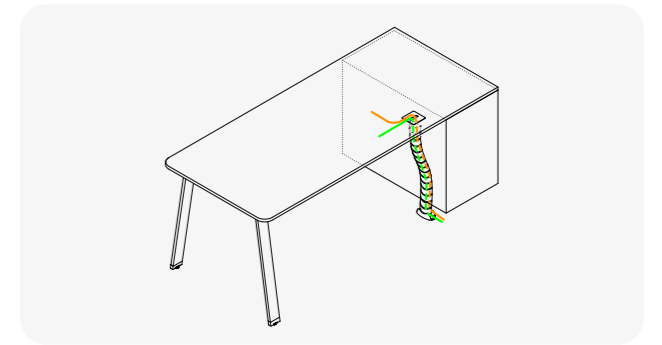
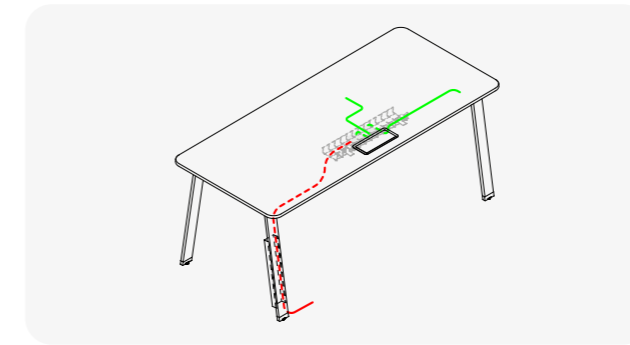



**66 - 71**

**accessori e componenti ·**

accessories and components · accessoires et composants ·  
Zubehör und Komponenten · accesorios y componentes



**72 - 75**

**accessori per elettrificazione ·**

accessories for electrification · accessoires pour électrification ·  
Zubehör für Elektrifizierung · accesorios para electrificación

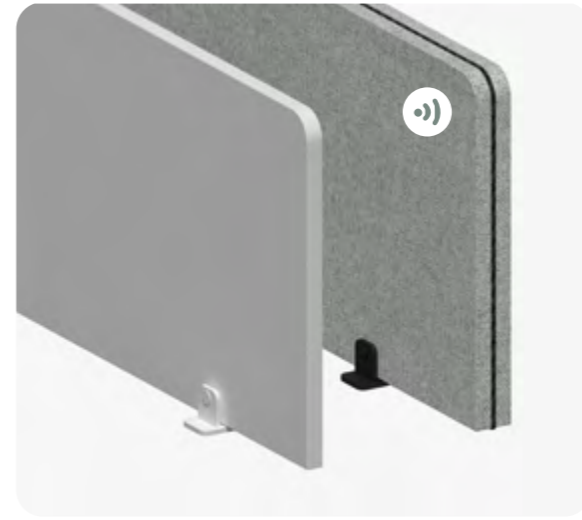

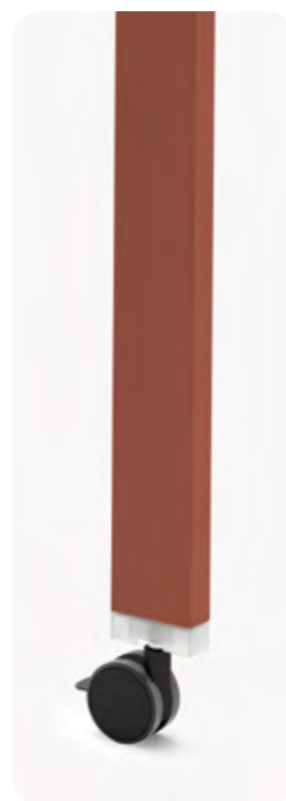

h 62 ÷ 86 cm

**Regolazione in altezza ogni 2 cm**  
Height adjustment every 2 cm  
Réglage hauteur tous les 2 cm  
Höhenverstellung alle 2 cm  
Ajuste de altura cada 2 cm





ø 8 cm  
h 10 cm

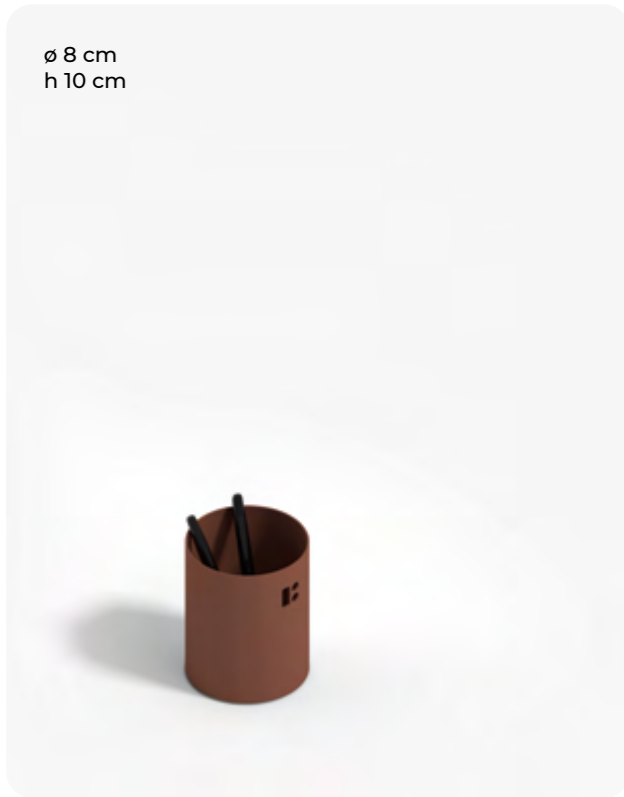

ø 27 cm  
h 40 cm

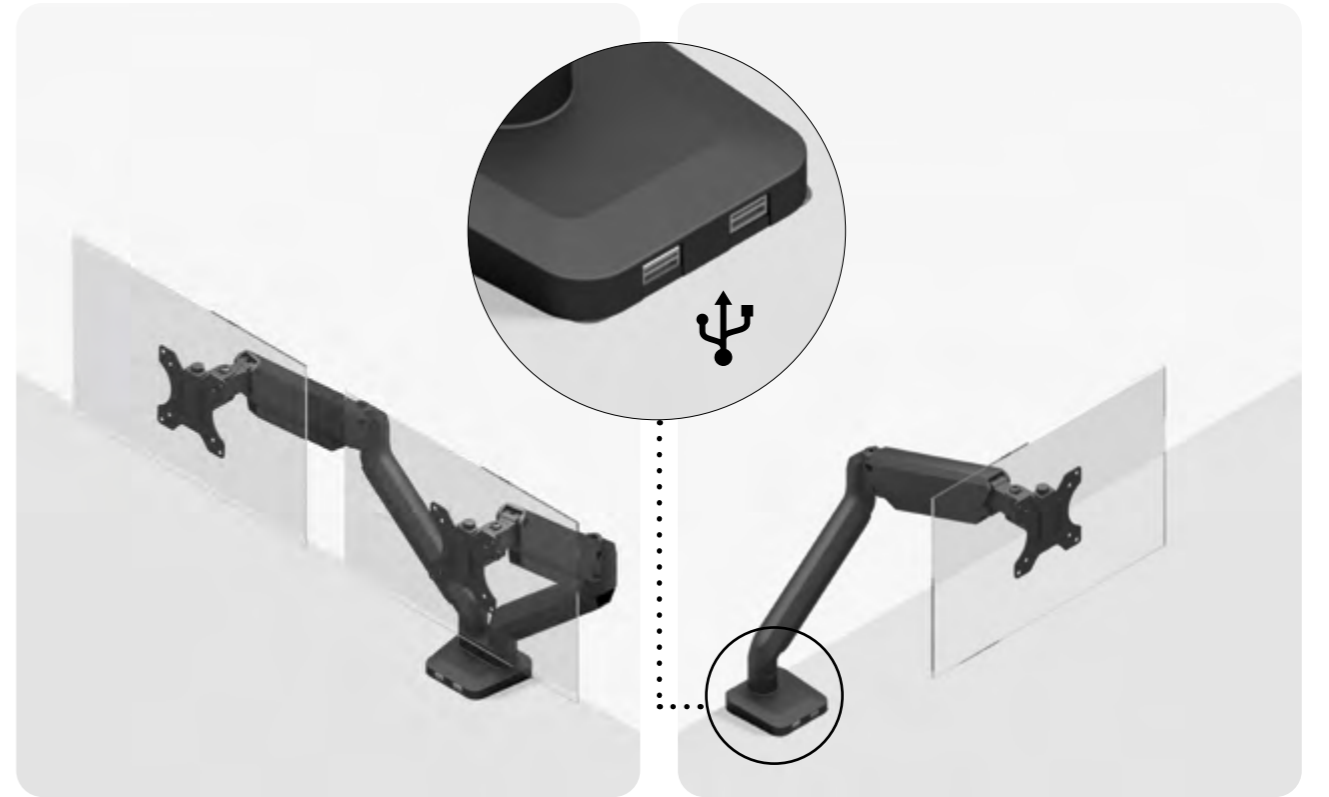



**elettrificazione sopra piano**, desktop electrification, électrification au-dessus du plateau,  
Elektrifizierung über den Tisch, electrificación encima de la tapa



**plastica**, plastic, plastique,  
Plastick, plástico



**plastica**, plastic, plastique,  
Plastick, plástico  
**laccato opaco**, lacquered matt, laqué mat  
matt lackiert, lacado mate

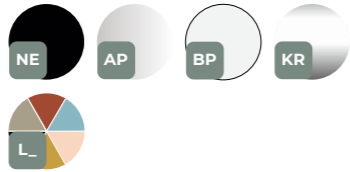

**metallo**, metal, métal,  
metall, metal



**metallo**, metal, métal,  
metall, metal



**plastica**, plastic, plastique,  
Plastick, plástico



**plastica**, plastic, plastique,  
Plastick, plástico



**metallo**, metal, métal,  
metall, metal





**elettrificazione sopra piano**, desktop electrification, électrification au-dessus du plateau,  
Elektrifizierung über den Tisch, electrificación encima de la tapa



**plastica**, plastic, plastique,  
Plastick, plástico

**laccato opaco**, lacquered matt, laqué mat  
matt lackiert, lacado mate



**plastica**, plastic, plastique,  
Plastik, plástico



**elettrificazione sotto piano**, under desktop electrification, électrification sous plateau,  
Elektrifizierung unter den Tisch, electrificación debajo de la tapa



**cestelli portacavi**, cable holder baskets, paniers porte-câbles,  
Kabelwanne, bandejas portacables





**melaminico** • melamine • mélamine • melamin • melamina

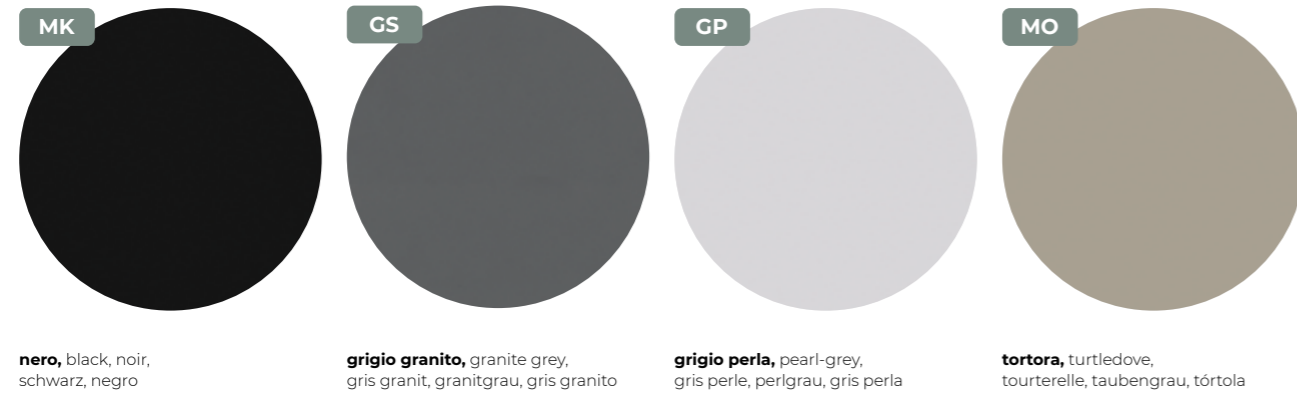

**nero**, black, noir, schwarz, negro

**grigio granito**, granite grey, gris granit, granitgrau, gris granito

**grigio perla**, pearl-grey, gris perle, perlgrau, gris perla

**tortora**, turtledove, tourterelle, taubengrau, tórtola

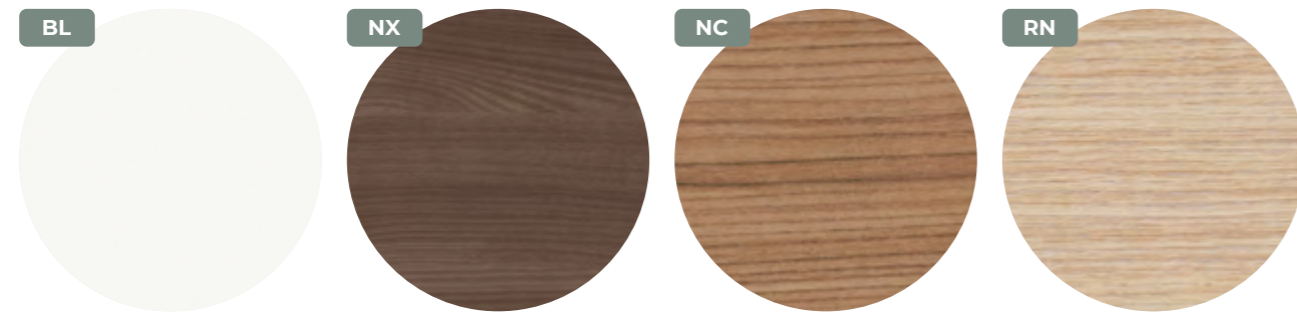

**bianco**, white, blanc, weiß, blanco

**noce lux**, walnut Lux, noyer Lux, Lux Nussbaum, nogal Lux

**noce canaletto**, canaletto walnut, noyer canaletto, Canaletto Nussbaum, nogal canaletto

**rovere naturale**, natural oak, chêne naturel, Natur Eiche, roble natural



**rovere anticato**, traditional oak, chêne vieilli, Eiche Antik, roble antiguo



**RA - Superficie antibatterica**  
Antibacterial surface, surface antibactérienne,  
Antibakterielle Oberfläche, superficie antibacteriana

**strutture metalliche** • metal structures • structures métalliques • metallgestelle • estructuras metálicas



**nero**  
black  
noir  
schwarz  
negro

**metallo crudo**  
raw metal  
métal brut  
rohes Metall  
metal bruto

**grigio granito**  
granite grey  
gris granit  
granitgrau  
gris granito

**tortora**  
turtledove  
tourterelle  
taubengrau  
tórtola

**epox alluminio**  
silver epoxy  
epoxy aluminium  
epoxy aluminium  
epoxidico aluminio

**bianco**  
white  
blanc  
weiß  
blanco



**cromo lucido**  
glossy chrome  
chromé brillant  
Chrom poliert  
cromo brillo

**oliva**  
olive  
olive  
olive  
oliva

**terracotta**  
terracotta  
terre cuite  
terrakotta  
terracota

**laccato opaco** • lacquered matt • laqué mat • matt lackiert • lacado mate

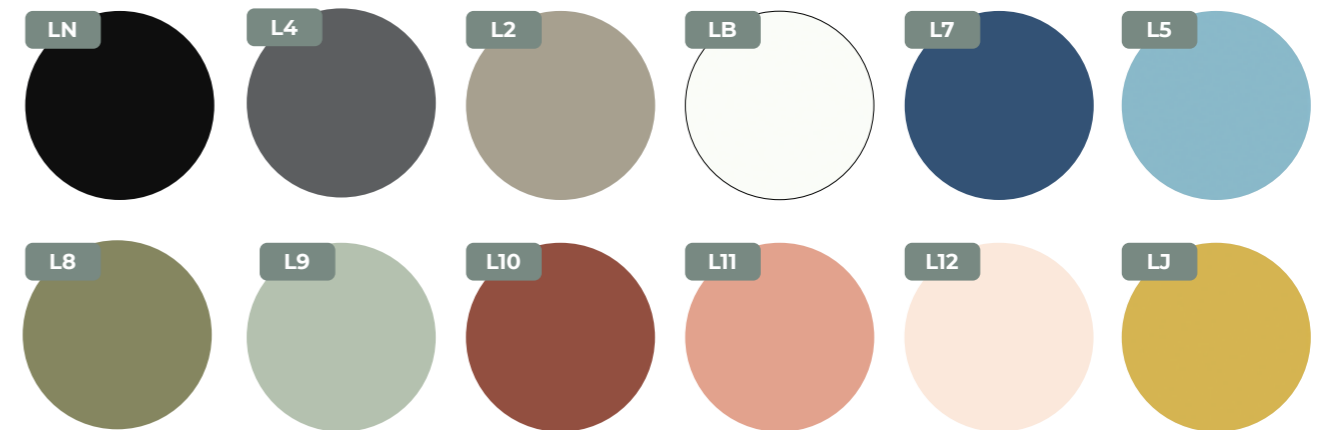

MIRAGE

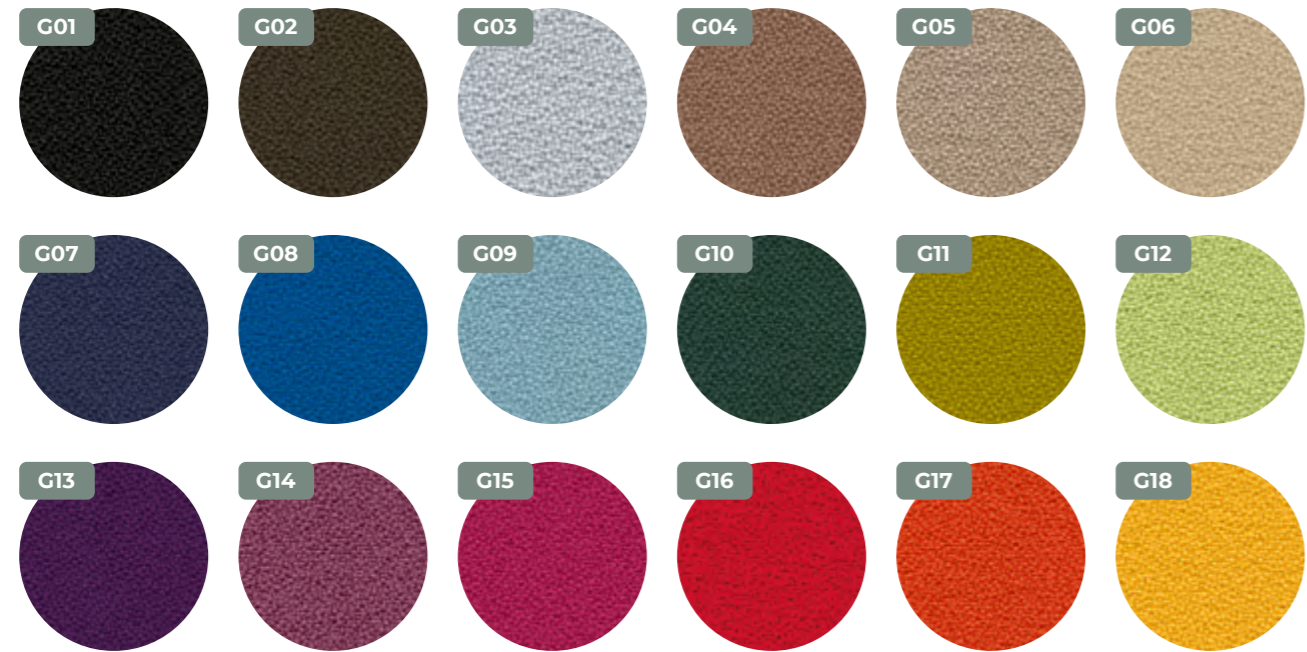

NEMI MELANGE

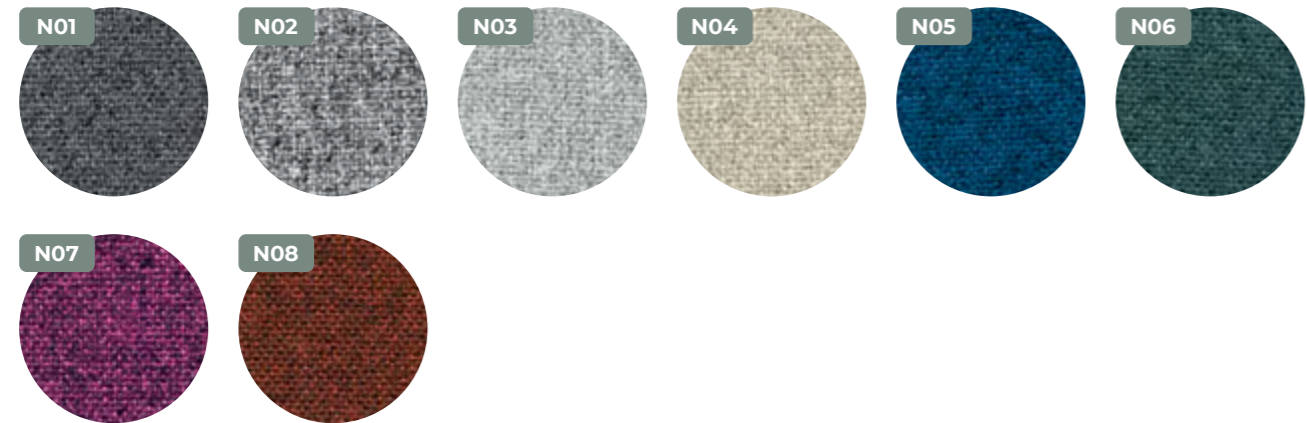

FENICE

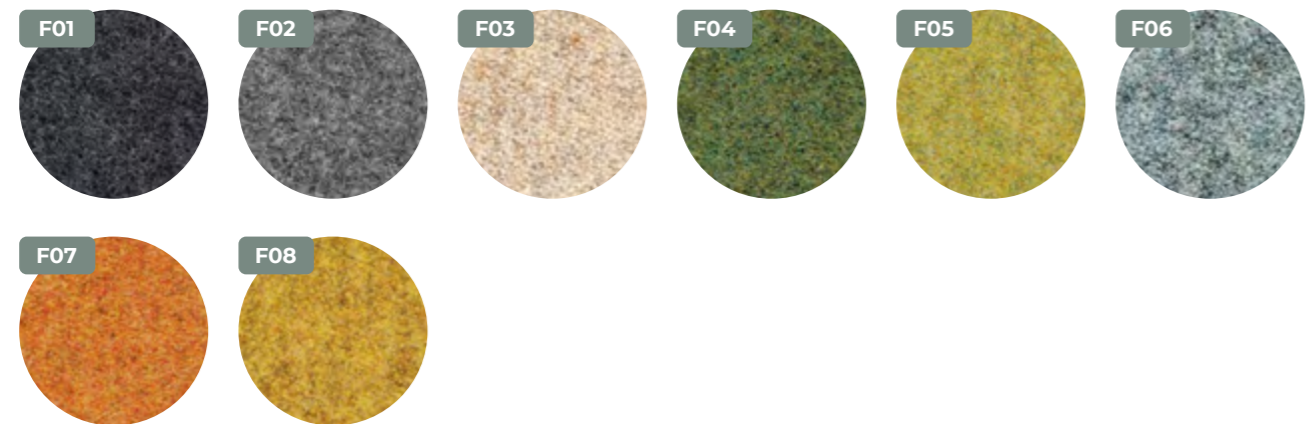

CONVERT MEL 4000

