

Framery Six™



The smart and soundproof office meeting room
shaping the workspace of tomorrow

framery



Framery Six is a smart meeting room for up to 6 people. This multifunctional soundproof meeting space is tailored for collaborative teamwork and enhanced for face-to-face and hybrid brainstorming sessions. With fine-tuned acoustics and top-notch soundproofing, it ensures privacy during discussions and virtual meetings. Framery Six's adaptive ventilation and automated lighting ensure your team can focus on what really matters and have a successful workday.

Framery Six / Product highlights



Workdays that flow with ease

Framery Six has been purposefully designed to make your workdays flow better. Find and book the pod in advance or on-the-fly from the Framery app. Or step inside and the pod automatically creates a reservation for you. Extend your reservation directly from the pod's touchscreen, or adjust your booking through the app.



Privacy you can trust

The fine-tuned acoustic structure provides A-Class soundproofing that allows the pod to be placed next to workstations without causing noise distractions to the user or to those outside of the pod. And echo-free interior acoustics make the pod a private, comfortable place for work and video calls.



Airflow that keeps you fresh

The pod recognizes when it's occupied, senses the temperature and humidity of the surroundings, and triggers adjustments to the airflow accordingly. Enhanced ventilation fully refreshes the air every minute, and ventilation can be easily adjusted through the pod's touchscreen display.



Lighting that makes you feel good

Multiple automated light sources adapt to your needs, with preset lighting options to choose between work or video modes. Video-optimized lighting helps you shine on video calls. Adjustments can be made quickly and easily through the touchscreen display.

Framery Six / Tech features



1. A-CLASS SOUNDPROOFING

Guaranteed privacy with fine-tuned Class A speech level reduction of 30dB – and the industry's top ISO 23351-1 rating for office phone booths.

2. FRAMERY OFFICE SOUND MASKING SYSTEM™

The embedded system is based on patent-pending technology that reduces noise distractions and protects speech privacy in office environments by adding a subtle, unobtrusive background sound outside of the pod. This ambient background noise, similar to air flow, is specifically designed to blend in with the office's noise atmosphere – making sounds less intelligible and therefore less distracting.

3. ADAPTIVE VENTILATION

Proprietary design enables unparalleled ventilation with maximum airflow of 187 l/s – surpassing industry standards around the world.

4. TEMPERATURE & HUMIDITY SENSORS

Sensors inside the pod recognize the temperature and humidity of the office environment, and automatically optimizes the airflow accordingly.

5. AUTOMATIC LIGHTING MODES

Dual adjustable 4000K LED light sources allow you to seamlessly switch between video or work modes – or make manual adjustments for personalized illumination.

6. 8-INCH TOUCHSCREEN

An intuitive, 8-inch high-resolution touchscreen makes it easy to control pod settings, adjust lighting and airflow, and extend calendar reservations effortlessly.

7. AUTOMATIC UPGRADES

A built-in 4G connection enables automatic over-the-air software updates – initiated instantly and silently in the background.

8. MMWAVE RADAR PRESENCE DETECTION

Millimeter-wave radar sensors immediately detect when someone enters or leaves the pod, allowing lighting and ventilation to adjust accordingly.

Occupancy data is gathered and displayed through Framery Connect to provide information about when the pod is being used the most.

9. FRAMERY CONNECT™

Gain insights from occupancy data, initiate advanced bookability functionalities, and connect your Framery Six to the entire office to get valuable usage data needed to improve the layout and efficiency of your workplace.

Framery Six / Design details

Framery Six combines the best features of a larger meeting room in a convenient, modular package. The luxurious and spacious interior comes equipped with a proper-sized meeting table that can be complemented with your own choice of seats. The pod's low threshold enables easy access, and the minimalistic design approach uses carefully curated materials, making it a sustainable choice.



Framery Six is designed to bring teams together - whether you're meeting face-to-face or collaborating online. The space is tailored for collaborative teamwork, and enhanced for face-to-face and hybrid brainstorming sessions.



The optional gather zone outside of Framery Six creates an additional meeting area, featuring matching carpet and a convenient add-on rail where a whiteboard or additional display can be attached. This effectively doubles the amount of working space that Framery Six can offer.



The exterior occupancy lights show at a glance whether the pod is available or already taken.

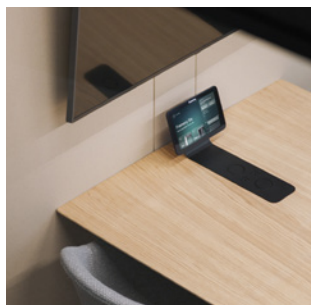

The custom-designed table comfortably accommodates an entire team, and built-in power outlets and optional coat hooks are provided for all your office accessories.



An optional interior whiteboard can be provided to make it even easier to collaborate during meetings.



Customize your pod to fit your workplace with hundreds of combinations of colors, fabrics, and high-quality materials to choose from.

Framery Six / Colors and finishes

EXTERIORS



CARPETS



TABLE TOPS



INTERIORS

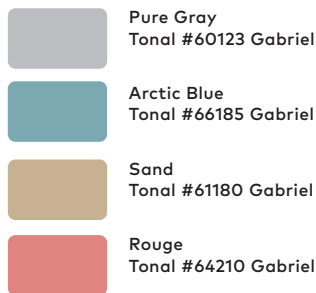

MATERIALS AND FINISHES



EXTERIOR PANELS made from steel feature a powder-coated matt finish. The lightweight panels are joined together seamlessly, with elegant curves that create a timeless design.



INTERIOR PANELS made from high-quality and recycled polyester have a vibrant and dynamic look thanks to the mix of the two-colored fabric.

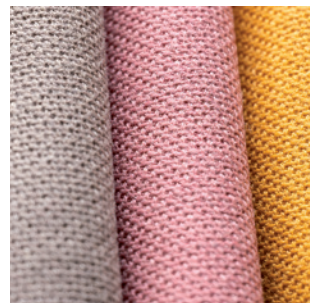

SUSTAINABLE QUALITY
Replaceable interior paneling on the walls and roof are made from PET sound-absorbing material. Anti-static, stain resistant low-loop pile carpeting covers the flooring.



CARPET FLOORING is anti-static, stain resistant, and durable, giving the pod an overall soft look and finish.

Framery workplace technology / Set your office up for success

Framery's workplace technology suite streamlines workdays, elevates productivity, and enhances the entire workplace experience. Access real-time occupancy data, make data-driven decisions, book meeting spaces easily, and boost focus, privacy, and productivity throughout the office. Set up your workplace for the people who use it – making it easier than ever to get work done. And you can enjoy these benefits without any deployment costs.

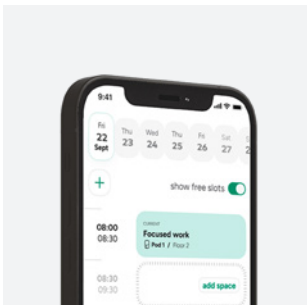

Framery App™

Manage your workday on the go with the Framery app – the easiest way to book pods and meeting spaces for every task throughout your day. Instantly check space availability and save your favorite spaces to see when they're free. Book spaces in advance or on the go directly from your phone, and manage your entire workday in one place.



Framery Office Sound Masking System™

The Framery office sound masking system improves the acoustics of the entire workplace. The embedded system is based on patent-pending technology that reduces noise distractions and protects speech privacy in office environments by adding a subtle, unobtrusive background sound outside of the pod. This ambient background noise, similar to air flow, is specifically designed to blend in with the office's noise atmosphere – making sounds less intelligible and therefore less distracting.

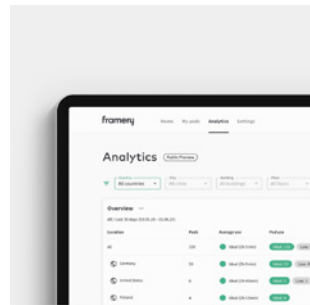

Framery Connect™

Make workplace management decisions based on insights from your office's occupancy data. Every connected space provides you with valuable usage data you need to improve the layout and efficiency of your workspace. See which spaces are functioning efficiently, which spaces need attention, and which spaces go unused. With real-time usage data you can provide enough spaces in the right places.



Framery Connect Sensor™

This palm-sized sensor expands the capabilities of Framery Connect – making it possible to collect usage data from any space in your workplace. From meeting rooms to collaborative spaces, the sensor can easily be attached to any space in your office to give you a complete overview of how your office is used. The simple and wireless sensor is equipped with internal 4G connectivity and an external battery boasting a 3-year battery life.

Unparalleled support

Get instant support from a Framery specialist for any issues that may arise with your smart pods or other products.

Always updated

Instantly receive software updates through your smart pod's 4G connection to enable developments and services into the future.

Privacy ensured

No identifiable user data is collected – only workspace occupancy information is tracked.

FRAMERY PLUS – EVERYTHING YOU NEED FOR A SUCCESSFUL WORKPLACE

Unlock all the tools and features your workplace needs to thrive with our subscription based Framery Plus™ – free of charge until the end of 2024.

Framery smart pods / Environmental data sheet

Framery's new smart pods set the standard in sustainability – with durability that is measured in decades, light-weight product structures, use of truly recyclable materials, and modularity that allows the life cycle of the products to be extended indefinitely. Framery participates in the Science Based Targets initiative, and has set emission reduction targets aligned with the goal of limiting global warming to 1.5°C compared to pre-industrial levels. Results of life cycle assessment of Framery products are verified by an independent third party and available in Environmental Product Declarations.



Optimal material use

Framery has achieved a 23% material reduction with its new line of products – which equals over 1 million kg of raw material annually – while increasing their level of performance compared to previous models. This has made it possible for Framery to reduce product prices as well. The carbon footprint in the manufacturing stage of the new products is 16% smaller on average. A change from plywood to steel as the main construction material also allows Framery to continue reducing its environmental impact and strive towards a 50% reduction in product CO₂ emissions by 2028.



Production and waste management

All our pods are manufactured in Tampere, Finland using zero-emission electricity. Our factory logistics are operated on biogas and renewable diesel. The material efficiency rate of our production was 94.9% in 2022. Virtually no waste goes to landfill.



Environmental impact

We have conducted life cycle assessment studies for our products to measure their environmental impacts. Alongside their carbon footprint, we also study other impacts such as resource depletion and water scarcity. The results are verified by an independent third party, and then published and registered as an EPD to provide stakeholders with reliable information on our products' environmental performance in a transparent way.



Product performance

The modular design of our pods facilitates a long product lifetime, and our customers typically use them for many years. The same pod can be used by one customer after another, enabling multiple life cycles and saving valuable resources. Thanks to their modular design, our pods are easy to disassemble, refurbish if needed, and reassemble at a new location. Our products are GREENGUARD Gold certified, and highly maintainable with easily available spare parts.



Extended life cycles

The most effective way for manufacturers to reduce the environmental impact of their products is to extend their life cycle. The durability of the all-steel structures of Framery's new products is measured in decades. Modular product structures allow the pods to be easily serviced and refurbished, extending their life cycles even further. At the end of their life, the products are fully recyclable as a result of eliminating composite and other hard-to-recycle materials.



Transportation

Logistical hubs in Singapore and the USA reduces air freight, and allows us to load our shipping containers more tightly. The products are made-to-order, and their modularity helps us achieve this with minimal impact.

Framery Six™

Technical specifications

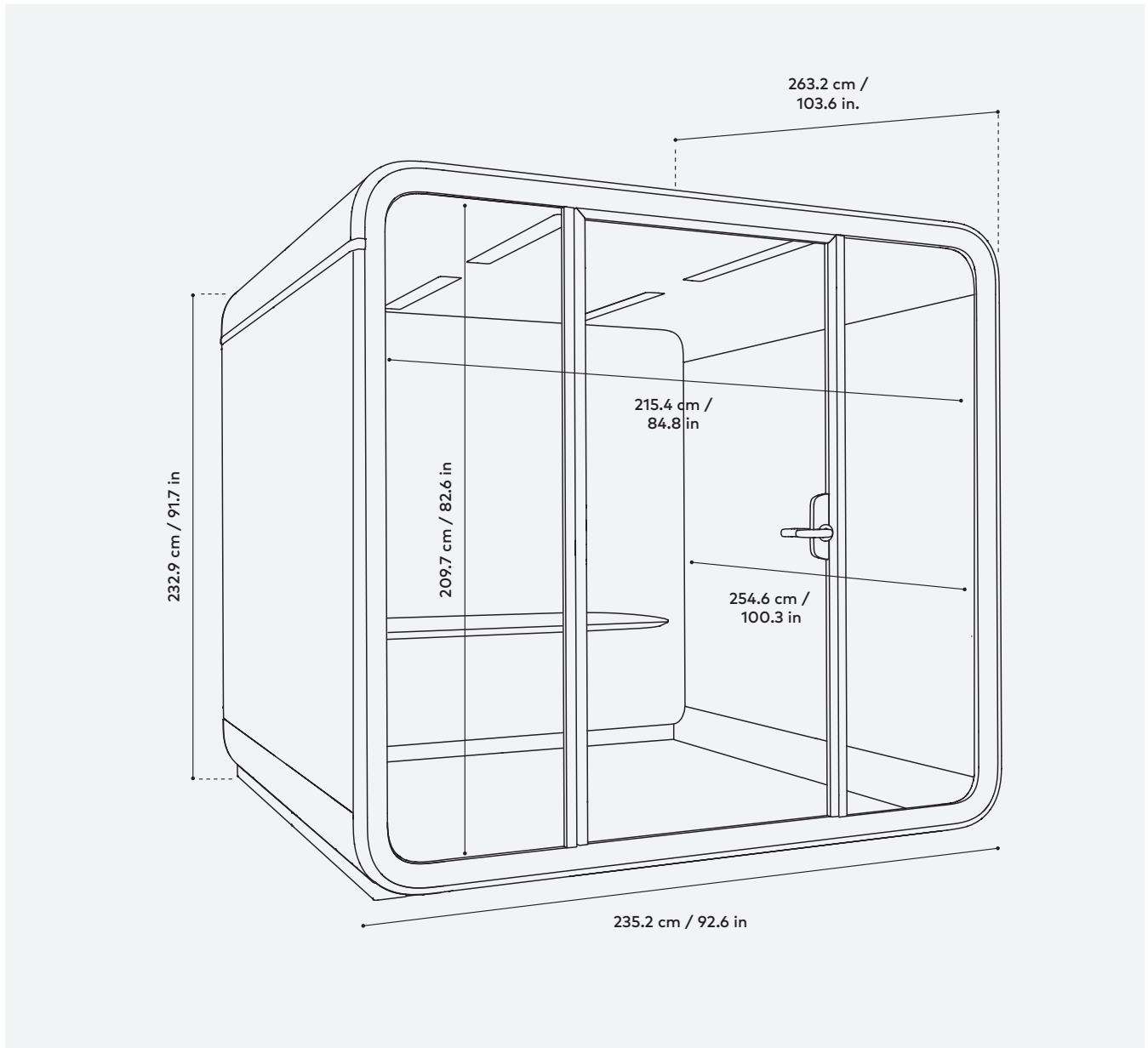

Performance

Speech level reduction: 30dB
Max airflow: 187 l/s
Low energy consumption: 145W

Sustainable design

Built to last for decades
Light-weight product structures
EOL 100% recyclable materials
Refurbishable & movable

Connectivity

Built-in 4G connection
Automatic software updates
Framery Connect digital services

Framery Six / Technical specifications

OVERVIEW

Soundproofing	CLASS A 30 DS,A (dB) reduction Speech level reduction DS,A (dB) is measured using ISO 23351-1. Pod can be placed next to workspaces without compromising privacy.
Sound masking	FRAMERY OFFICE SOUND MASKING SYSTEM™ A pre-fitted sound masking system improves the soundscape of the office outside the pods with an effective radius of 5 m / 16 ft.
Ventilation	MAXIMUM AIRFLOW 187 l/s, 397 CFM (674.6 m ³ /h) DEFAULT AIRFLOW 149 l/s, 316 CFM (536 m ³ /h) when in use. After use, the pod refreshes itself with a higher ventilation speed. ON STANDBY MODE 76 l/s, 161 CFM (274 m ³ /h) ADJUSTABLE DIRECTIONAL AIRFLOW Choose between direct and indirect airflow
Lighting	CEILING LIGHT Color temperature 4000K, illuminance up to 500lux on the table top. VIDEO LIGHT Color temperature 4000K, illuminance up to 350lux on the user's face. PRE-SET LIGHTING MODES Standard mode & Video call mode. The lighting can also be adjusted manually.
Presence detection	SENSOR TECHNOLOGY mmWave radar
Dimensions	EXTERIOR with air filter housing 232.9 × 235.2 × 263.2 cm / 91.7 × 92.6 × 103.6 in (h, w, d) DOORWAY 209.7 × 96.6 cm / 82.6 × 38 in (h, w) WEIGHT 718 kg / 1582.9 lb (Framery Six Base 693 kg / 1527.8 lb) THRESHOLD 1.25 cm / 0.5 in
Touchscreen location	On the table (Framery Six Base: on the wall).
Connectivity	Framery smart pods gather anonymous occupancy data, measuring when and how often spaces are used. Users in the space cannot be identified and no personally identifiable data is collected. The anonymous data is transferred via built-in 4G connectivity, or through a Wi-Fi connection and compiled and shown in the Framery Connect platform.

DIMENSIONS / MAIN VIEW

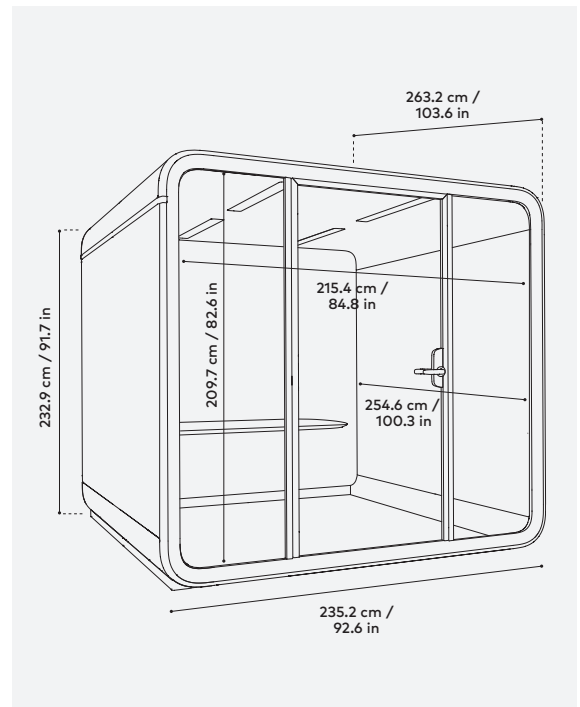

Framery Six is UL GREENGUARD GOLD certified



Framery Six shipped in North America is UL 962 listed

Framery Six / Technical specifications

MATERIALS

Exterior & structure	EXTERIOR PANELS Powder coated matt steel panels FRAMES Structure matt black aluminum. DOOR FRAME Structure matt black aluminum GLASS Sound control laminated glass (4 + 4 mm / 0.16 + 0.16 in) CHASSIS Light steel and PET sound-absorbing structure HANDLE Custom designed black metal
Interior materials	INTERIOR PANELS PET sheets laminated with recycled polyester fabric UPHOLSTERY FABRIC Gabriel Tonal CARPET Antistatic and stain resistant low loop pile carpet. TABLE Table top is birch plywood laminated with white, black anti-fingerprint, or oak veneer. TABLE LEG Structure black metal
Furniture dimensions	TABLE 94 cm x 140 cm / 37 in x 55.1 in (w, d) Fixed height from floor 72 cm / 28.3 in MAX LOAD FOR THE TABLE 60 kg / 131 lb
Optional accessories	INTERIOR WHITEBOARD 102.3 x 206.3 cm / 40.3 x 81.2 in (h, w) MONITOR WALL MOUNT Maximum monitor size 50". Maximum weight 30 kg / 66 lbs with flat VESA 100 x 100, 200 x 100, 200 x 200, 300 x 200, 300 x 300, 400 x 200, 400 x 300 or 400 x 400 mounting surface. Monitor not included. Possibility to mount on both walls. COAT HOOKS Structure black metal EXTERIOR TABLET MOUNT With easy set-up. GATHER ZONE Includes the same whiteboard and monitor wall mount as interior, and additional exterior carpet.

DIMENSIONS / TOP VIEW

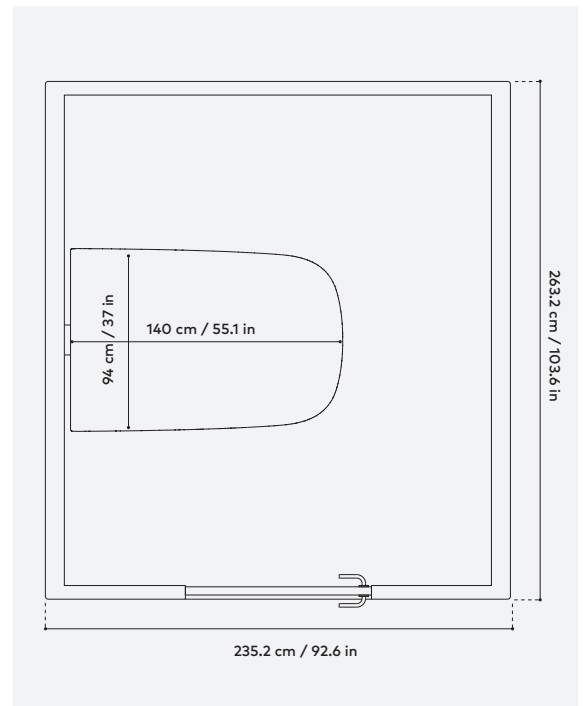

SAFETY

Fire safety	No fire hazardous materials are used in Framery pods. The fire safety of all surface materials, upholstery and acoustics materials of our products are tested and classified by either national or international standards. Framery provides additional safety measurements to adhere to local regulatory requirements.
Seismic safety	A seismic anchoring kit for a pod is available for the seismic regions. The kit consists of brackets that further reinforce the pod structure to withstand heavy seismic forces.

Framery Six / Technical specifications

POWER AND SPACE REQUIREMENTS

Power

FRAMERY SIX ESSENTIALS OUTLETS

2 × on-table / under-table power outlets, 2 × under-table power outlets, 2 × USB-C PD charge ports (65 W). Optional in-table outlets (max 2) 0–1 × HDMI port, 0–2 × LAN ports (with cables)

FRAMERY SIX LITE OUTLETS 2 × on-table / under-table power outlets, 2 × under-table power outlets. Optional in-table outlets (max 4) 0–2 × USB-C PD charge ports (65 W), 0–1 × HDMI port, 0–4 × LAN ports (with cables)

FRAMERY SIX BASE OUTLETS 4 × power outlets on the same side of the pod as the touchscreen. Optional outlets (max 4): 0–2 × USB-C PD charge ports (65 W), 0–4 × LAN ports (with cables)

The location of power outlets may vary based on country regulations.

POWER CONSUMPTION Default settings 145W. Highest settings 202W. Standby mode 28W.

INPUT 100–240 VAC, 10 A, 50–60 Hz

OUTPUT AC (POWER OUTLET) 100–40 VAC (8 A max) 50–60 Hz

OUTPUT USB-C PD CHARGE PORT 65W

Space requirements

DOOR OPENING RATIO 180°

Door handedness

Left-handed by default (can also be installed right-handed)

Operating space

From back to front (pod depth + doorway) 359.8 cm / 141.6 in. Room height requirement 235 cm / 92.5 in

Installation space

Installation requires 50 cm / 19.7 in of free space around the pod

Movability

Relocate the pod without the need for disassembly by adding casters with a movability kit. Compatible with Framery Four and Six. The kit is reusable. Multiple pods can be moved with one kit

SHIPPING CRATE DIMENSIONS

Crate 1

SIZE 222 × 89 × 149 cm / 87.4 × 35 × 58.7 in (l, w, h). **WEIGHT** 392 kg / 864 lb

Crate 2

SIZE 224 × 113 × 116 cm / 88.2 × 44.5 × 46.7 in (l, w, h). **WEIGHT** 505 kg / 1113 lb

Crate 1 is stacked on top of Crate 2.

DIMENSIONS / POWER CORD SPECIFICATIONS

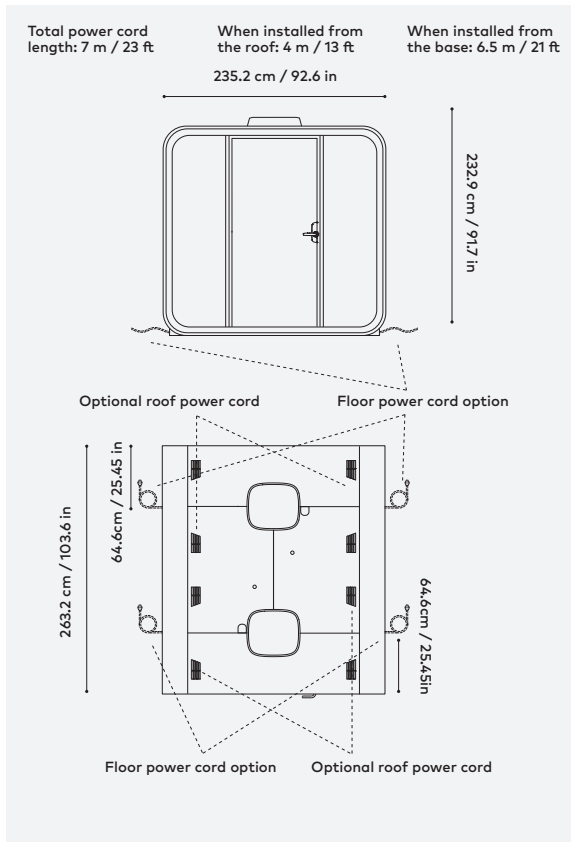

DIMENSIONS / OPERATING SPACE

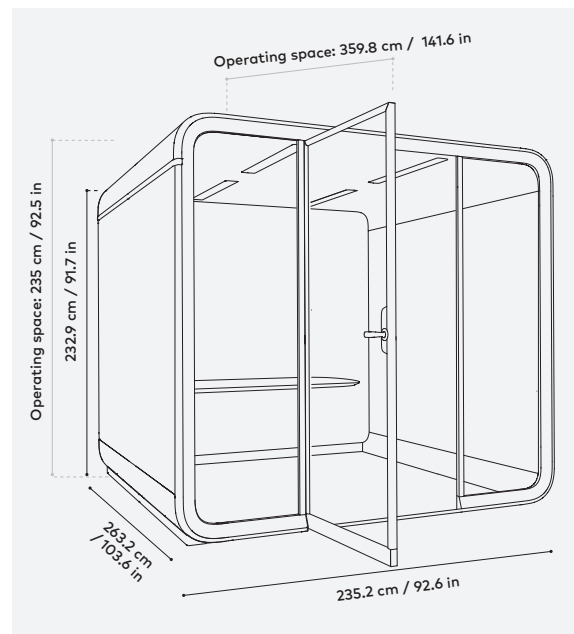

For the doers,
leaders, thinkers,
dreamers, creators,
teams, pioneers
and innovators.
**For people who
get it done.**