



# CATALOGO

2BE  
collection

# L'UFFICIO

## the office

IT

Rappresenta la tua identità,  
il percorso che stai compiendo  
e i valori che ti accompagnano.

Comfort, tecnologia e funzionalità contribuiscono  
al tuo benessere e facilitano la riuscita delle attività  
che ti vedono protagonista nella vita lavorativa.

Noi di Codutti, dal 1954 artigiani e industriali  
insieme, creiamo soluzioni d'arredo per ufficio  
di alta gamma con l'attenzione e la cura frutto di  
oltre sessant'anni di esperienza nella produzione  
e nel design made in Italy, per le aziende, per gli  
studi professionali e i progetti contract, anche sui  
mercati internazionali.

Tutte le nostre collezioni – dagli arredi direzionali  
agli operativi, dalle sedute alle pareti divisorie –  
nascono dall'unione di artigianalità e innovazione  
tecnologica e si contraddistinguono dall'alto  
livello di qualità e cura del dettaglio propri del  
marchio Codutti.

La flessibilità per noi è un valore: prendiamo in  
carico i tuoi progetti e siamo al tuo fianco nel  
fornire soluzioni personalizzate che superano le  
tue aspettative.

Un ufficio unico e coinvolgente,  
che ti emoziona ogni giorno.

EN

Shows who you are,  
what your journey is,  
and your principles are.

Comfort, technology and functionality: all  
contribute to your wellness and make easier those  
tasks that see you as the main actor in your daily  
business life.

We at Codutti have been both craftsmen and  
industrialists since 1954; we create design  
solutions for the highline office, paying the  
attention for the detail we have learned from more  
than sixty years of experience with the made in  
Italy production and design.

It's for companies, for professionals and contract  
projects, also on global markets.

All our collections - from the executive to the  
operative office, from the chairs to the partition  
walls - are born from the union between  
craftsmanship and technology innovation, and  
standout thanks to high quality level and care for  
details, which has always been the  
main distinction of the Codutti brand.

We believe flexibility is an added value: we take  
in your project requests and stand at your side to  
give you customized solutions that go beyond your  
expectations.

A unique appealing office that excites you day  
after day.





# 2BE

## collection

design by DANIELE CANUTI

IT

Il mondo office sta vivendo una vera e propria rivoluzione: un nuovo modo di lavorare che passa da una dimensione individuale ad una più corale, nella quale il valore si sposta dal singolo al team. Di conseguenza anche gli spazi di lavoro devono mutare, riconfigurandosi per soddisfare le esigenze di questo nuovo modo di fare. È proprio pensando a questa evoluzione che nasce la collezione 2BE, disegnata da Daniele Canuti: una famiglia di arredi versatili e facilmente ricollocabili, progettati per adattarsi con facilità ai contesti lavorativi e contract più fluidi, e alle mutevoli necessità operative: lavorare, concentrarsi, condividere, comunicare o concedersi una pausa. La cifra stilistica della 2BE è la linea curva, come conseguenza dell'eliminazione dell'angolo a 90 gradi sui piani. Cosicché tutte le persone che vi stanno intorno possano guardarsi negli occhi e condividere piacevolmente progetti ed idee. Questa linea si ritrova anche nelle strutture tubolari metalliche, che sorreggono i piani - di lavoro nel caso di tavoli e scrivanie, o di contenimento per le librerie - e gli iconici roof, disponibili sia in versione fonoassorbente che dotati di una vasca per piante.

EN

The office world is experiencing a real revolution: a new way of working that from an individual dimension become a whole, where the importance moves from the individual person to the team. Consequently, the work spaces must also change to meet the needs of this new way of living and working. It is precisely with this evolution that the 2BE collection, designed by Daniele Canuti, was born: a group of versatile and easily relocatable furnishings, designed to adapt to the most fluid work and contract contexts, and to changing operative needs: work, focus, share, communicate or simply take a break.

The stylistic code of the 2BE is the curved line, as a consequence of the 90-degree angle top removal. All the people can look into each other's eyes and pleasantly share projects and ideas. This line continues with the tubular metal structures, which support the tops - worktops for desks and tables, or the storage units for bookcases - and the iconic roof, available both in sound-absorbing versions and equipped with a plant box.

# S o m m a r i o

■ workstation	9
■ sharing	21
■ round	33
■ break	41
■ storage units	45
■ smart meeting wall	65





workstation



workstation



Composizione workstation con top portapiante Workstation set with plant holder top



## workstation



Cassetto singolo ■ Single drawer

**IT** Le workstation della linea 2BE sono composte da sistemi a doppia postazione frontale da due a infinite postazioni lavorative con la possibilità di poter scegliere fra tre differenti lunghezze per piani di lavoro. La struttura metallica poggia su supporti fissi e piedini di regolazione. Possono essere integrati con accessori come pannelli schermo, cassetti sottopiano, appendiabiti, top access o fori passacavi. Inoltre è possibile aggiungere tramite innesto anche un "tetto" fonoassorbente o con vasca portapiante. Completano la collezione dei mobiletti laterali, con o senza porta CPU ed un mobile da posizionare in testa alle composizioni, con struttura porta piante o senza.

**EN** 2BE workstations can be combined of benches from two to an infinite number of work posts with the possibility to choose three different lengths for the worktops. The metal structure rests on fixed supports with adjustable feet. The benches can be completed with different accessories: screen panels, drawers under the top, hangers, top access or cable plugs. It is also possible to add a sound-absorbing or a plant-holder "roof". The collection is completed with side cabinets with or without CPU holder and a cabinet to be placed at the beginning of the compositions, it can be with or without plant holder.

**FR** Les workstation de la ligne 2BE sont composés de bench de deux postes de travail à l'infini avec la possibilité de pouvoir choisir trois longueurs différentes pour les plans de travail. La structure métallique s'appuie sur des supports fixes et des pieds réglables. Les benches peuvent être équipées avec des panneaux écrans, des tiroirs sous le plateau, des cintres, un accès supérieur ou des passe-câbles. De plus, il est également possible d'ajouter un "toit" insonorisant ou une jardinière. La collection est complétée par des armoires latérales avec ou sans supports CPU et un meuble à placer au sommet des compositions, avec ou sans structure jardinière.



Cassetto Doppio ■ Double drawer



Mobile laterale ■ Side cabinet



workstation



Mobile laterale porta CPU ■ CPU holder side cabinet



# workstation





workstation





workstation



Particolare della gamba ■ Detail of leg



s h a r i n g



sharing



## sharing



**IT** Tavolo multifunzione con forma ellittica di tre diverse dimensioni e due differenti altezze. La struttura potrà avere supporti fissi e piedini di regolazione o con ruote che permetteranno di spostare il tavolo con facilità e riconfigurare così le aree lavorative a seconda dell'attività da svolgere. I tavoli sharing potranno essere integrati con accessori come pannelli schermo, appendiabiti, top access o fori passacavi. Sarà possibile inoltre aggiungere tramite innesto anche un "tetto" fonoassorbente o con vasca portapiante.

**EN** Elliptical multifunctional table available in three different sizes and two heights. The structure can be equipped with fixed supports and adjustable feet or with wheels that allow you to move the table easily and permit to adapt working areas to the needs. The sharing tables can be completed with different accessories: screen panels, drawers under the top, hangers, top access or cable plugs. It is also possible to add a sound-absorbing or a plant-holder "roof".

**FR** Table multifonctionnelle de forme elliptique en trois tailles différentes et deux hauteurs. La structure peut être dotée de supports fixes et des pieds réglables ou bien des roues qui vous permettront de déplacer la table facilement et ainsi de reconfigurer les zones de travail en fonction de l'utilisation que vous souhaitez en faire. Les tables de partage peuvent être équipées avec des panneaux écran, des cintres, un accès supérieur ou des trous de câble. Il sera également possible d'ajouter un "toit" insonorisant ou une jardinière.





sharing



Tavolo Sharing su ruote H 110 cm ■ Sharing table on wheels H 110 cm



sharing



■ Appendiabiti ■ Hanger



Tavolo Sharing su ruote H 110 cm ■ Sharing table on wheels H 110 cm



sharing



Tavolo Sharing fisso H 74 cm ■ Fixed Sharing table H 74 cm



sharing



r o u n d



round



Tavolo Round Tree fisso H74 cm ■ Fixed Round Tree table H74 cm



## round

**IT** Tavolo multifunzione con forma circolare di tre diametri e con due diverse altezze. La struttura potrà avere supporti fissi con piedini di regolazione o su ruote e potranno essere integrati con accessori come pannelli schermo, appendiabiti, top access o fori passacavi. Sarà possibile inoltre aggiungere tramite innesto anche un "tetto" fonoassorbente o con vasca portapiante.

**EN** Circular multifunctional table available in three different diameters and two heights. The structure can be equipped with fixed supports and adjustable feet or with wheels. The round tables can be completed with different accessories: screen panels, drawers under the top, hangers, top access or cable plugs. It is also possible to add a sound-absorbing or a plant-holder "roof".

**FR** Table multifonction de forme circulaire de trois différents diamètres et de deux hauteurs. La structure peut être dotée de supports fixes avec des pieds réglables ou bien des roues. Les tables de partage peuvent être équipées avec des panneaux écran, des cintres, un accès supérieur ou des trous de câble. Il sera également possible d'ajouter un "toit" insonorisant ou une jardinière.



Tavolo Round su ruote H110 cm ■ Round table on wheels H110 cm



round





round



b r e a k



break



Tavolo Break ■ Break Table



## break

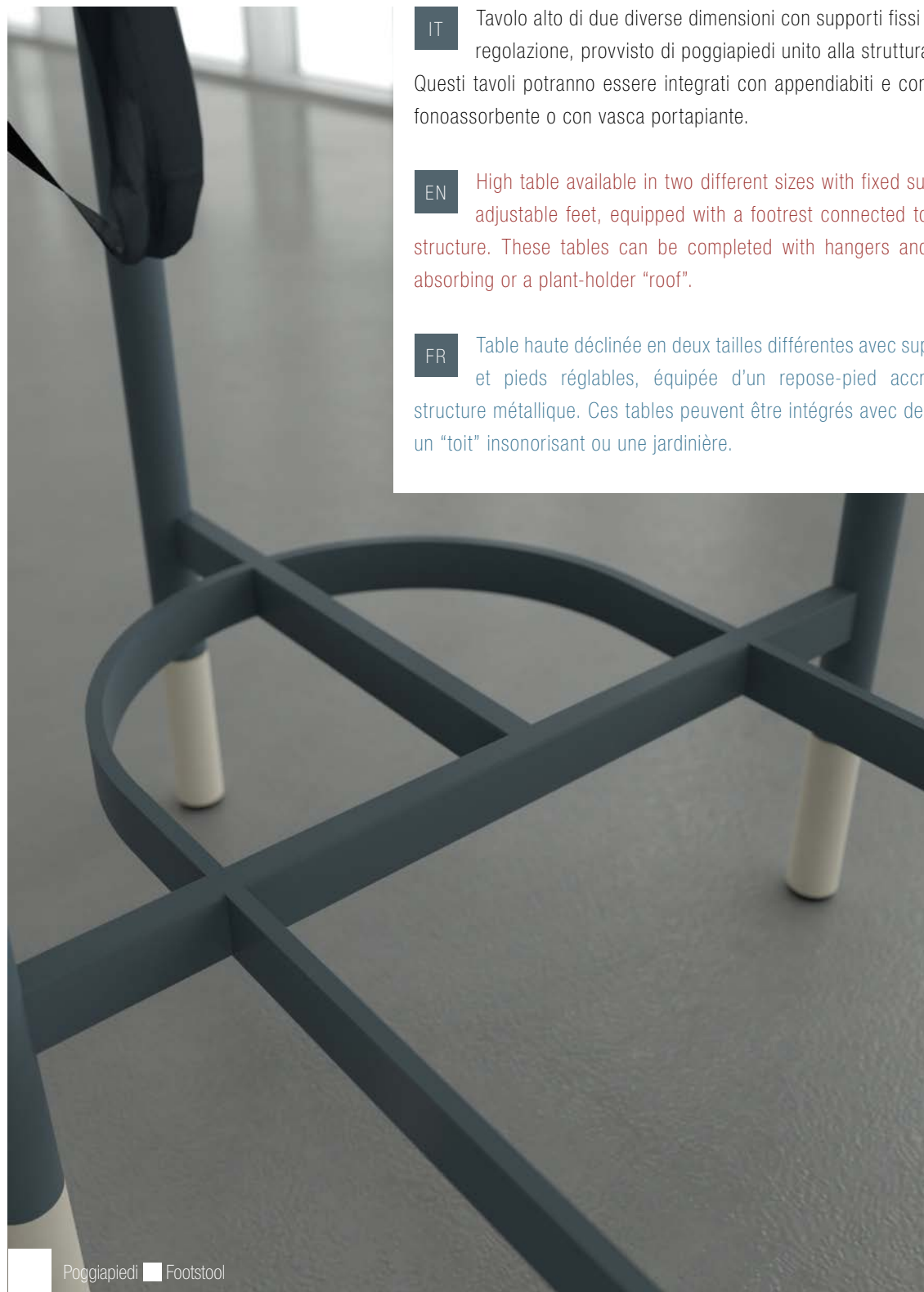

**IT** Tavolo alto di due diverse dimensioni con supporti fissi e piedini di regolazione, provvisto di poggiapiedi unito alla struttura metallica. Questi tavoli potranno essere integrati con appendiabiti e con un "tetto" fonoassorbente o con vasca portapiante.

**EN** High table available in two different sizes with fixed supports and adjustable feet, equipped with a footrest connected to the metal structure. These tables can be completed with hangers and a sound-absorbing or a plant-holder "roof".

**FR** Table haute déclinée en deux tailles différentes avec supports fixes et pieds réglables, équipée d'un repose-pied accroché à la structure métallique. Ces tables peuvent être intégrés avec des cintres et un "toit" insonorisant ou une jardinière.

Poggiapiedi ■ Footstool



storage units



# storage units





storage units





## storage units

**IT** Serie di contenitori a struttura unica con misure ed altezze variabili. Tutti i mobili avranno una struttura comune che compone la base a cui potranno essere innestate delle prolunghe per ottenere molteplici soluzioni. Completano la gamma di prodotti contenitori i seguenti articoli: i lockers (con serratura o combinazione), armadi con ante battenti, contenitori per la raccolta differenziata o semplici mensole. Questi prodotti sono integrabili con vasca porta piante sul top di finitura.

**EN** Single storage unit available with different sizes and heights. All the cabinets rest on a common base on which many compositions can be created. In the range of storages, we also have the following articles: lockers (with lock or combination), cabinets equipped with hinged doors, cabinets for waste sorting or simple shelves. It is also possible to add a plant holder on the top.

**FR** Meubles à structure unique avec dimensions et hauteurs variables. Tous les meubles auront une structure commune qui constitue la base à partir de laquelle des extensions peuvent être ajoutées pour obtenir plus solutions. La gamme de produits conteneurs comprend également: des casiers (avec serrure ou combinaison), conteneurs avec portes battantes, conteneurs pour le tri des déchets ou simplement des étagères. Ces produits peuvent être intégrés avec un bac à plantes sur le dessus de finition.



Contenitori con ante e Lockers ■ Cabinets and Lockers





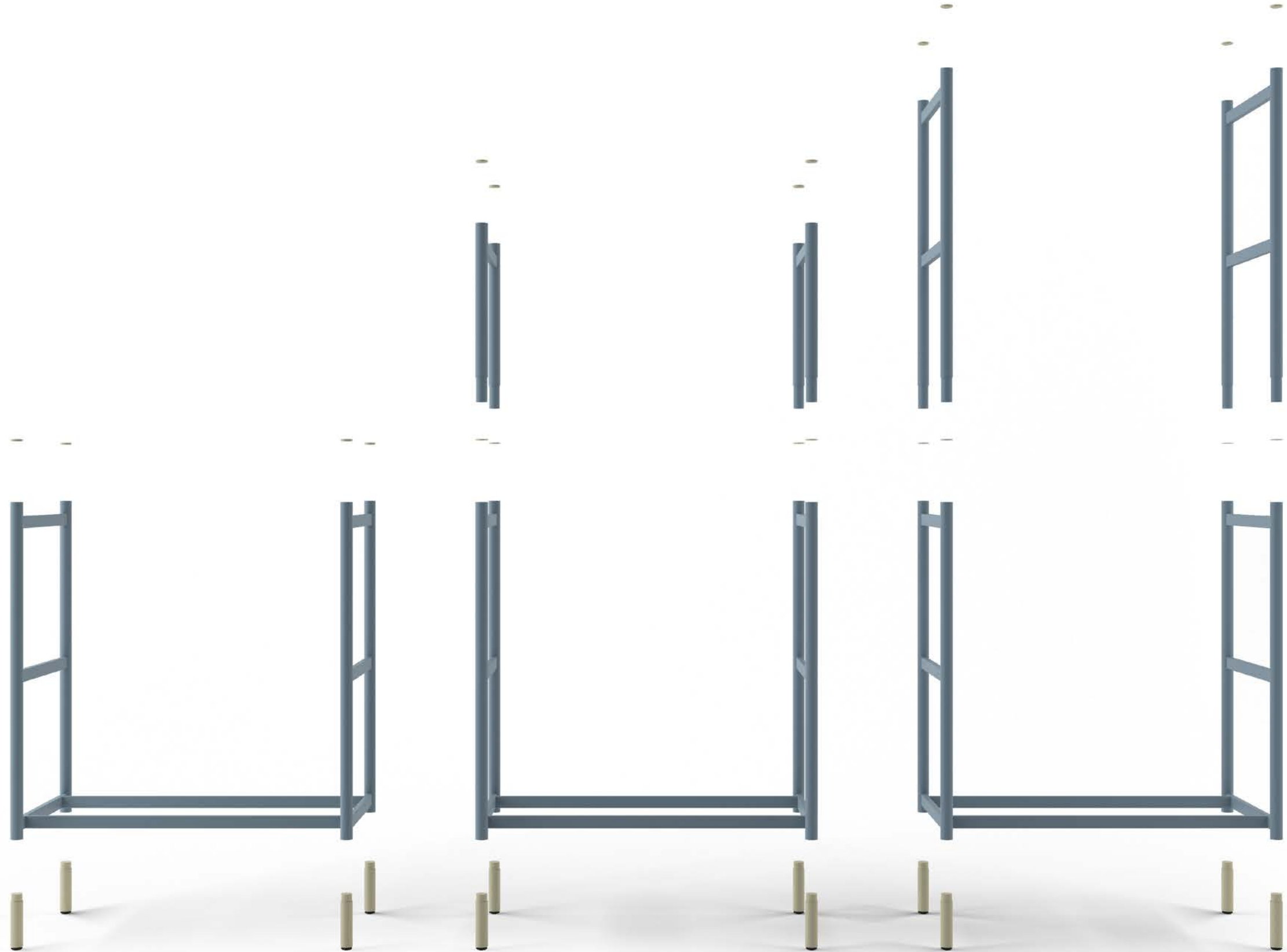

# storage units



Mensole ■ Shelves





storage units









storage units



Contentori con ante e mensola superiore Storage units with doors and top shelf



storage units



Composizione con contenitori e seduta doppia ■ Composition with storage units and double seat



storage units

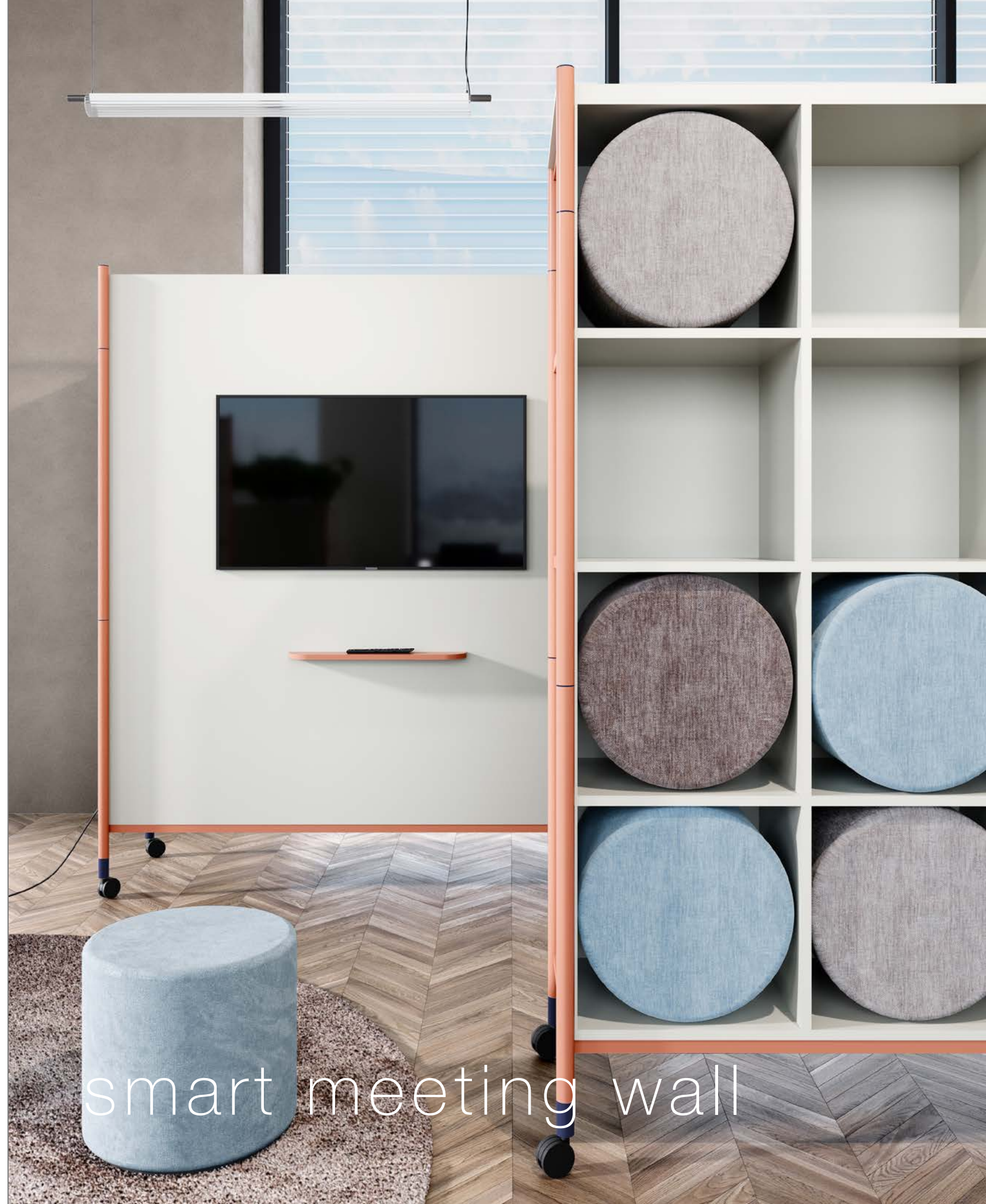

smart meeting wall



## smart meeting wall



**IT** Mobile contenitore a giorno su ruote contenente 8/12/16 pouf, pensato per brevi meeting informali o veloci corsi di formazione. Su un lato del mobile sarà possibile applicare una lavagna o un monitor (in questo modello sono previsti anche vani per il cablaggio e l'elettificazione). Le ruote permetteranno di spostare con facilità lo Smart Wall nel nostro ambiente e renderlo così versatile alle varie attività da svolgere.

**EN** Open storage unit on wheels containing 8/12/16 pouf, designed for short informal meetings or quick training courses. On one side of the cabinet, it is possible to apply a blackboard or a monitor (compartments for wiring and electrification can be provided). The wheels allow you to move the Smart Wall easily and permit to adapt working areas to the needs.

**FR** Meuble à jour sur roulettes contenant 8/12/16 poufs, conçu pour de courtes réunions informelles ou des formations rapides. Sur un côté du meuble, il sera possible d'appliquer un tableau noir ou un moniteur (dans ce modèle, il y a aussi des compartiments pour le câblage et l'électrification). Les roulettes vous permettront de déplacer facilement le Smart Wall dans notre environnement et ainsi le rendre polyvalent pour les diverses activités à réaliser.

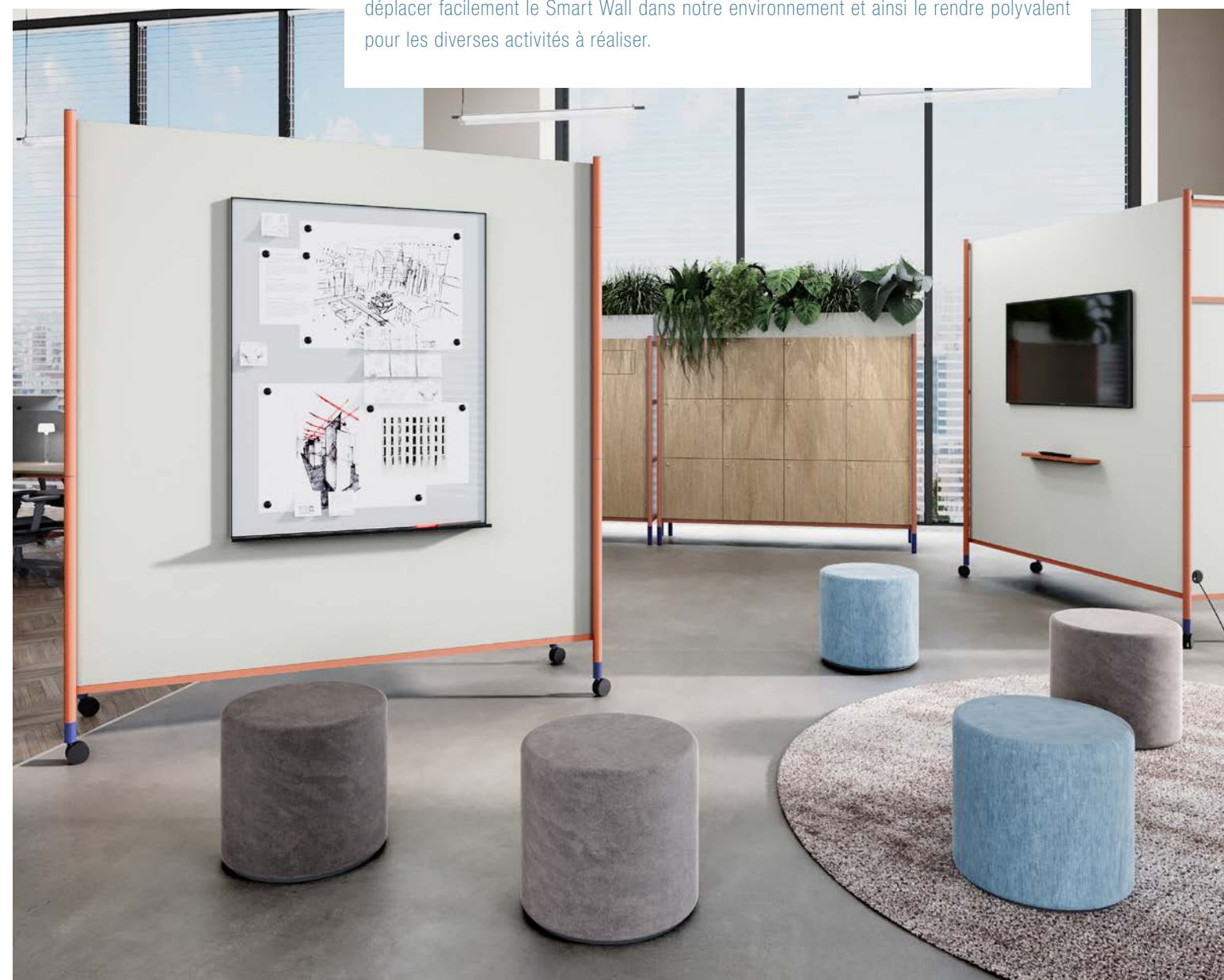



smart meeting wall





## Workstation H74 cm

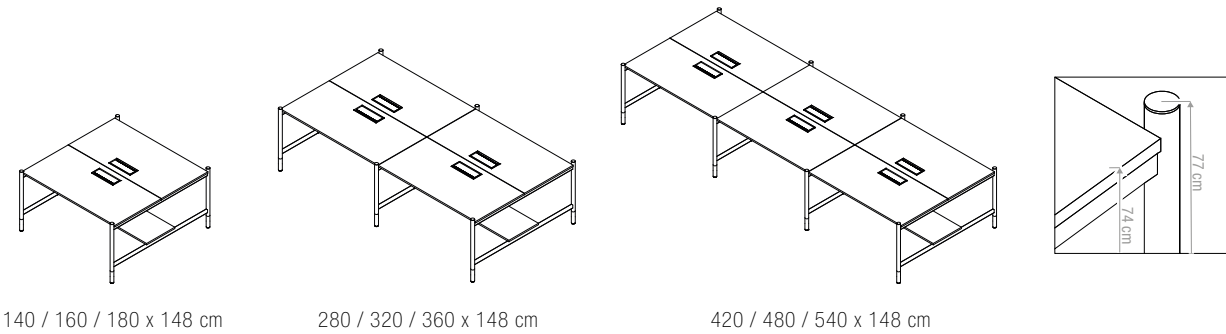

140 / 160 / 180 x 148 cm

280 / 320 / 360 x 148 cm

420 / 480 / 540 x 148 cm

## Accessori workstation - Workstation accessories H100 cm

Top fonoassorbente  
140 / 160 / 180 x 148 x 100h.Top portapiante  
140 / 160 / 180 x 148 x 120h.Mobile laterale  
149 x 535 x 109h. cmPorta CPU  
40 x 70 x 74h. cmMobile con anta  
40 x 70 x 74h. cm

## Sharing fisso - Fixed sharing - H74 cm



208 x 128 x 77h. cm

248 x 148 x 77h. cm

288 x 148 x 77h. cm

## Sharing su ruote - Sharing on wheels - H74 cm



208 x 128 x 77h. cm

248 x 148 x 77h. cm

288 x 148 x 77h. cm

## Sharing fisso - Fixed sharing - H110 cm

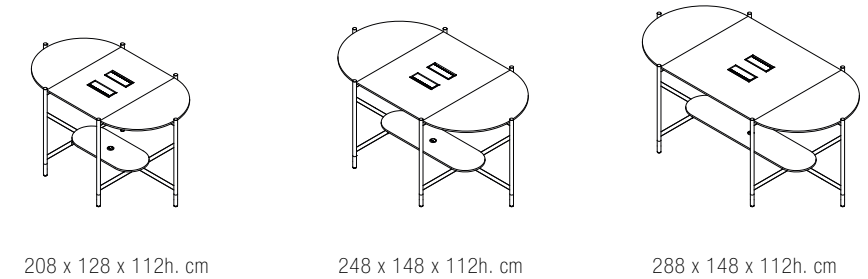

208 x 128 x 112h. cm

248 x 148 x 112h. cm

288 x 148 x 112h. cm

## Sharing su ruote - Sharing on wheels - H110 cm



208 x 128 x 112h. cm

248 x 148 x 112h. cm

288 x 148 x 112h. cm

## Accessori workstation - Workstation accessories H110 cm

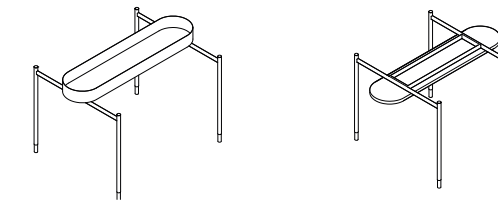
Top portapiante  
160 x 128 x 108h. cm  
200 / 240 x 148 x 108h. cmTop fonoassorbente  
160 x 128 x 100h. cm  
200 / 240 x 148 x 100h. cm

## Tavolo break - Break table - 250x50 cm H110 cm

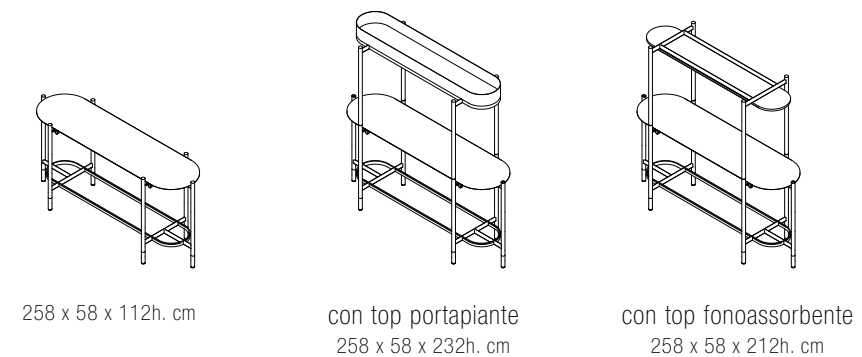

258 x 58 x 112h. cm

con top portapiante  
258 x 58 x 232h. cmcon top fonoassorbente  
258 x 58 x 212h. cm



### Round fisso - Fixed round H74 cm

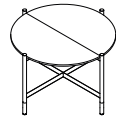

Ø 128 x 77h. cm

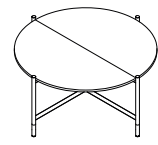

Ø 168 x 77h. cm

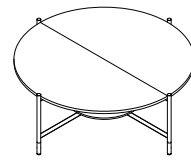

Ø 208 x 77h. cm

### Round su ruote - Round on wheels H74 cm

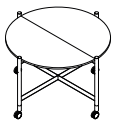

Ø 128 x 77h. cm

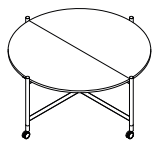

Ø 168 x 77h. cm

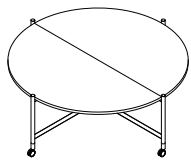

Ø 208 x 77h. cm

### Round fisso - Fixed round H110 cm

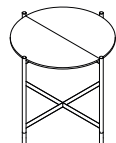

Ø 128 x 112h. cm

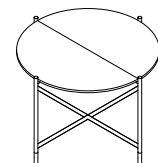

Ø 168 x 112h. cm

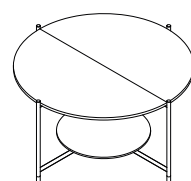

Ø 208 x 112h. cm

### Round su ruote - Round on wheels H110 cm

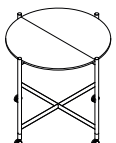

Ø 128 x 112h. cm

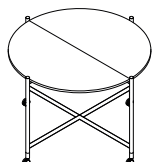

Ø 168 x 112h. cm

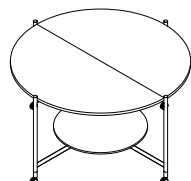

Ø 208 x 112h. cm

### Round Tree - H74 cm

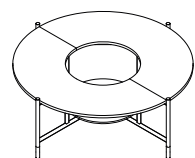

Ø 208 x 77h. cm

### Accessori Round - Round accessories

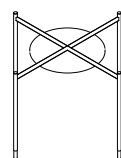

Top fonoassorbente  
Ø 128 / 168 / 208 x 100h. cm

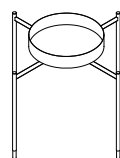

Top portapiante  
Ø 128 / 168 / 208 x 120h. cm

### Smart Wall

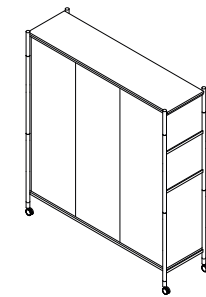
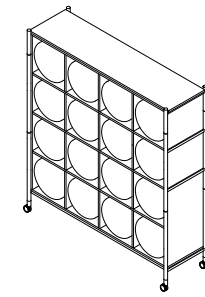

Struttura per lavagna/monitor 208 x 53 x 227h. cm

### Contenitori a giorno - Open Cabinets

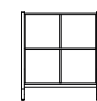

108 / 158 / 208 x 53 x 127h. cm

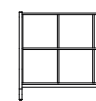

108 / 158 / 208 x 53 x 177h. cm

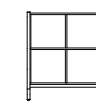

108 / 158 / 208 x 53 x 227h. cm

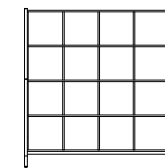
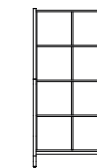
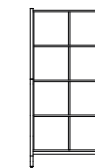
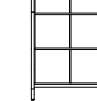
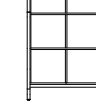
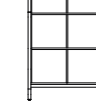

108 / 158 / 208 x 53 x 227h. cm

### Lockers

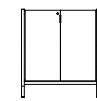

108 / 158 / 208 x 53 x 127h. cm

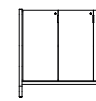

108 / 158 / 208 x 53 x 177h. cm

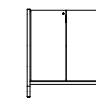

108 / 158 / 208 x 53 x 227h. cm

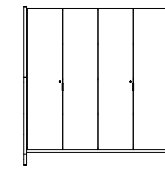
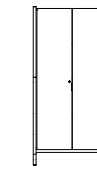
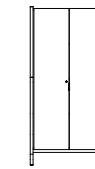
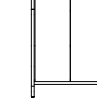
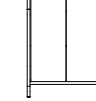
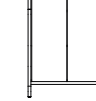

108 / 158 / 208 x 53 x 227h. cm

### Contenitori ante battenti - Cabinets with hinged doors



108 / 158 / 208 x 53 x 127h. cm



108 / 158 / 208 x 53 x 177h. cm



108 / 158 / 208 x 53 x 227h. cm

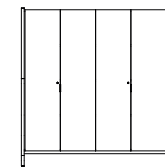
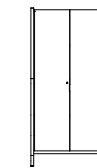
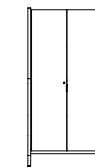

108 / 158 / 208 x 53 x 227h. cm

### Mensole - Shelves



149 / 199 / 249 x 53 x 127h. cm



149 / 199 / 249 x 53 x 177h. cm



149 / 199 / 249 x 53 x 227h. cm

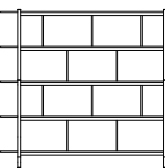
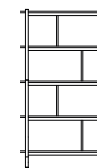
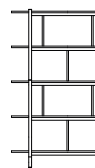

149 / 199 / 249 x 53 x 227h. cm



## Locker con mensole - Lockers with shelves

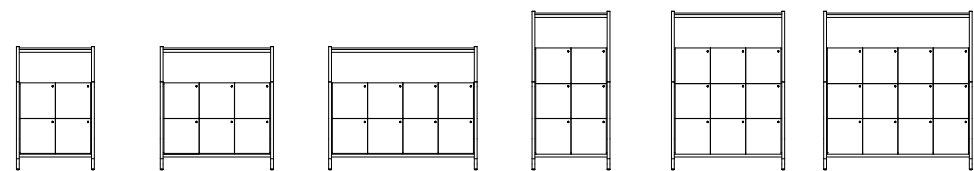

108 / 158 / 208 x 53 x 177h. cm

108 / 158 / 208 x 53 x 227h. cm

## Contenitori con mensole - Cabinets with shelves

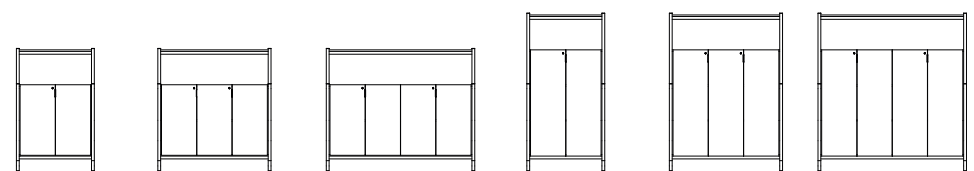

108 / 158 / 208 x 53 x 177h. cm

108 / 158 / 208 x 53 x 227h. cm

## Raccolta differenziata - Waste sorting cabinets

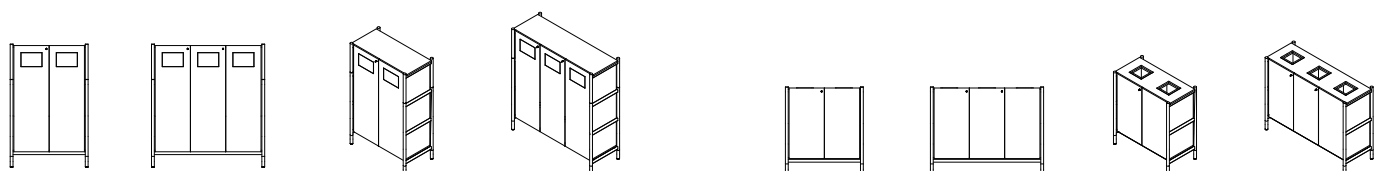

108 / 158 x 53 x 177h. cm

108 / 158 x 53 x 127h. cm

## Sedute - Seatings

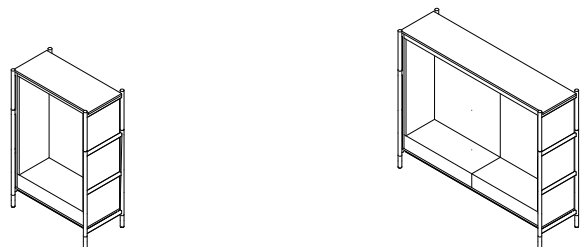

Seduta singola 108 x 53 x 177h. cm

Seduta doppia 158 x 53 x 177h. cm

# Materiali e Finiture - Materials & Finishes

## Colori custom - Custom colours



RAL

## Melaminici - Melamine



White



Aluminium

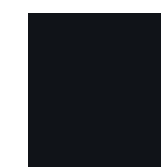

Black



Pearl Grey



Oak



Walnut

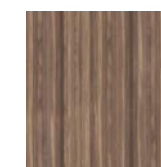

Nogal Carillo



Noce Oceano

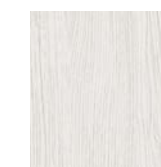

Olmo

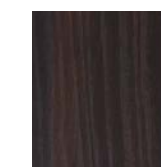

Moresco

## Laccature e vernici - Lacquers and paints

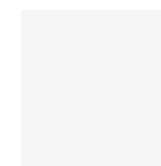

Neve (RAL 9016)



Denim (RAL 5014)



Ciliegia (RAL 3011)



Arancio (RAL 2000)



Crema (RAL 1013)



Notte (RAL 9004)



Marine (RAL 5009)



Oliva (RAL 6011)



Cielo (RAL 5024)



Nuvola (RAL 7047)



codutti

# codutti

**IT** Codutti è un brand italiano di arredamento per gli spazi di lavoro. Dal 1954 è interprete di un modo di vivere l'ufficio in equilibrio tra originalità ed estetica senza tempo. In tutti questi anni Codutti è sempre stato sinonimo di qualità ed eleganza, in tutte le sue proposte: Executive, Workstations, Aree meeting e Aree comuni. Il catalogo del brand – che include tavoli e scrivanie, tavoli meeting, contenitori, front desk, sistemi, divani e sedie – non è che il punto di partenza per soddisfare le esigenze dei clienti: grazie alla produzione interna, è infatti tutto possibile.

**EN** Codutti is an Italian furniture brand for workspaces. Since 1954 it has been an interpreter of a balanced way of living the office, between originality and timeless aesthetics. Throughout these years Codutti brand has always been synonymous with quality and elegance in all its proposals: Executive collections, Workstations and Meeting areas. The catalogue of the brand - which includes tables and desks, meeting tables, storage units, front desks, sofas and chairs - that's just the starting point to meet customer needs: thanks to the in-house production, Codutti can satisfy any of their requests.





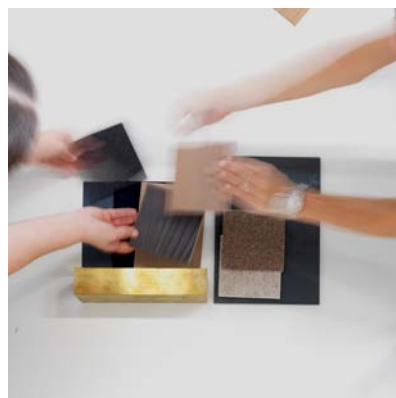

## Produzione

**IT** La realtà produttiva Codutti è un insieme integrato di artigianalità e tecnologia: efficienza, precisione, eccellenza qualitativa e produzione interna. Sono questi i tratti distintivi del processo produttivo dell'azienda, pensato per offrire ai clienti la massima flessibilità e quindi l'alto grado di personalizzazione di ogni arredo.

**EN** The Codutti production is a whole integrated chain, combining craftsmanship and technology. Efficiency, precision, qualitative excellence and in-house production: these are the hallmarks of the company production process, designed to offer customers the maximum flexibility and the highest level of customization of each piece of furniture.

## Personalizzazione totale

**IT** Sia che si tratti di realizzare da zero un arredo totalmente su misura, o di customizzare le dimensioni, i materiali o le finiture di una collezione già a catalogo, Codutti ha una soluzione ad hoc. Nell'headquarter del brand, collocato in provincia di Udine all'interno di uno dei principali distretti produttivi italiani dell'arredo, prende vita il processo di creazione: dalla progettazione tecnica, alla produzione, alla logistica.

**EN** Whether it is to realize a piece of furniture from scratch, or to customize the dimensions, materials or finishes of a standard collection, Codutti will find your own solution. In the brand headquarters, located in the province of Udine, one of the main Italian furniture production districts, the production process takes place: from technical design to production and logistics.

## Codutti people

**IT** L'universo Codutti è fatto di persone che progettano e realizzano sistemi di arredo per altre persone, in grado di trasformare i propri uffici nel loro mondo. Un modo innovativo di concepire gli ambienti professionali contemporanei: da luoghi del fare a luoghi dell'essere.

**EN** The Codutti universe is made up of people who design and manufacture furnishing systems for other people. People who wish to see their office transformed into their own world. An innovative way to conceive contemporary professional environments: from places of doing to places of being.







